

# 850 Model VOLVO 850 1 9 9 5

[This manual deals with the operation and care of your Volvo](#)

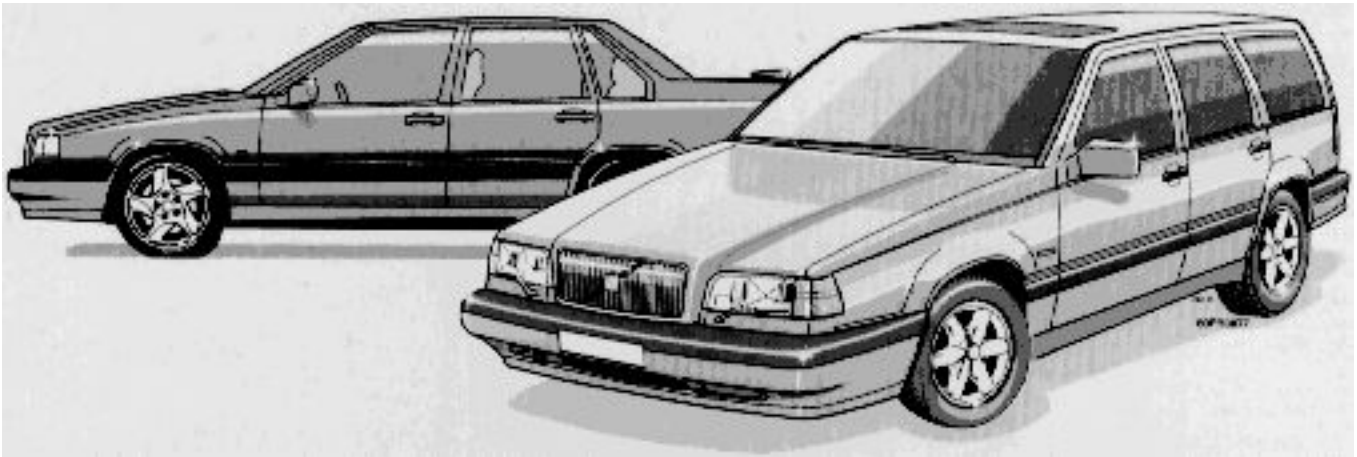

Welcome to the world-wide family of Volvo owners. We trust that you will enjoy many years of safe driving in your Volvo, an automobile designed with your safety and comfort in mind. To help ensure your satisfaction with this vehicle, we encourage you to familiarize yourself with the equipment descriptions, operating instructions and maintenance requirements/recommendations in this manual. We also urge you and your passengers to wear seat belts at all times in this (or any other) automobile. And, of course, please do not operate a vehicle if you may be affected by alcohol, medication or any impairment that could hinder your ability to drive.

Your Volvo is designed to meet all applicable safety and emission standards, as evidenced by the certification labels attached to the door opening and on the left wheel housing in the engine compartment.

[Contents](#)

Important

Before you operate your car for the first time, please familiarize yourself with the BREAK-IN information on page 4:2. You should also be familiar with the information in the first three chapters of this manual.

Information contained in the balance of the manual is extremely useful and should be studied after operating the vehicle for the first time.

This manual is structured so that it can be used for reference. It should thus be kept in the car for ready access.

Do not export your Volvo to another country before investigating the country's applicable safety and exhaust emission requirements. In some cases it may be difficult or impossible to comply with these requirements. Modifications to the emission control system(s) may render your Volvo not certifiable for legal operation in the U.S., Canada and other countries.

All information, illustrations and specifications contained in this manual are based on the latest product information available at the time of publication. Volvo reserves the right to make model changes at any time, or to change specifications or design, without notice and without incurring obligation.

**CAUTION:** T-5R turbo models have reduced ground clearance due to the design of the front spoiler. Please observe caution when e.g., driving onto garage hoists, through drifted snow or when other road debris is encountered, or when parking near curbs.

[Instruments and controls ... 1](#)

[Body and interior ... 2](#)

[Occupant safety, Reporting Safety Defects ... 3](#)

[Starting and driving ... 4](#)

[Wheels and tires ... 5](#)

[In case of emergency ... 6](#)

[Car care ... 7](#)

[Service and routine maintenance ... 8](#)

[Specifications ... 9](#)

© Volvo Cars of North America



[Contents](#) | [Top of Page](#)

## Instruments and controls

### Instruments, switches and controls

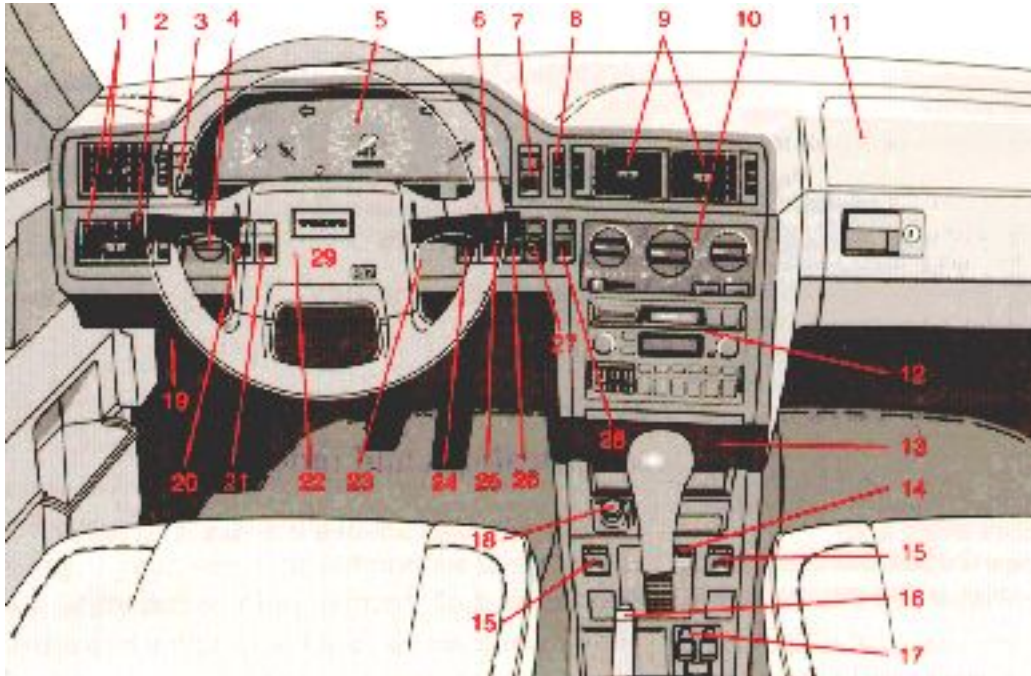

### pg. 1:1 Instruments, switches and controls (cont.)

**IMPORTANT!** (Automatic transmission only)

Your car is equipped with a Shiftlock-Keylock system.

#### SHIFTLOCK:

When your car is parked, the gear selector is locked in the (P)ark position. To release the selector from this position, turn the ignition key to position II (or start the engine), depress the brake pedal, press the button on the front side of the gear selector and move the selector from (P)ark.

If it is necessary to manually override the Shiftlock system, see page 6:17 for instructions.

#### KEYLOCK

This means that when you switch off the ignition, the gear selector must be in the (P)ark position before the starting (ignition) key can be removed from the ignition switch.

## ANTI-LOCK BRAKE SYSTEM (ABS)

The ABS system in your car performs a self-diagnostic test when the vehicle first reaches the speed of approximately 20 mph (30 km/h). The brake pedal will pulsate several times and a sound may be audible from the ABS control module. This is normal.

The pages in this section provide detailed descriptions of the vehicle's instruments and controls. Note that vehicles may be equipped differently, depending on special legal requirements.

### Page

<a href="#">1:19</a>	1 Air vents
<a href="#">1:6</a>	2 Turn signals, high/low beams
<a href="#">1:15</a>	cruise control
<a href="#">1:8</a>	3 Rear fog light, instrument illumination
<a href="#">1:6</a>	4 Headlights, parking lights
<a href="#">1:2-1:5</a>	5 Instruments
<a href="#">1:7</a>	6 Windshield wiper/washer
<a href="#">1:9</a>	7 Hazard warning flashers
<a href="#">1:19</a>	8 Air mix
<a href="#">1:19</a>	9 Air vents
<a href="#">1:19-1:23</a>	10 Heating and ventilation controls
<a href="#">3:4, 3:6</a>	11 Passenger side SRS (air bag) hatch
<a href="#">1:25-1:53</a>	12 Audio system
<a href="#">1:17</a>	13 Ash tray
<a href="#">6:17</a>	14 Shiftlock override button (automatic transmission only)
<a href="#">1:16</a>	15 Electrically heated front seats (optional)
<a href="#">1:17</a>	16 Parking brake
<a href="#">1:24</a>	17 Electrically operated windows
<a href="#">2:7</a>	and side door mirrors

- [1:17](#) 18 Cigarette lighter
- [2:10](#) 19 Hood release
- 20 Front fog lights (optional)
- 21 Space for additional equipment
- [1:18](#) 22 Adjustable steering wheel
- [1:7](#) 23 Starting (ignition) switch/steering wheel lock
- 24 Space for additional equipment
- [1:3, 1:5, 1:9](#) 25 Traction control system (optional)
- [2:9](#) 26 Electrically operated sun roof (optional)
- [1:12-14](#) 27 Trip computer (optional)
- [1:9](#) 28 Heated rear window/heated door mirrors
- [3:4](#) 29 Horn/SRS

Some of the items above are available on certain models only.

[pg. 1:2 Instruments](#)

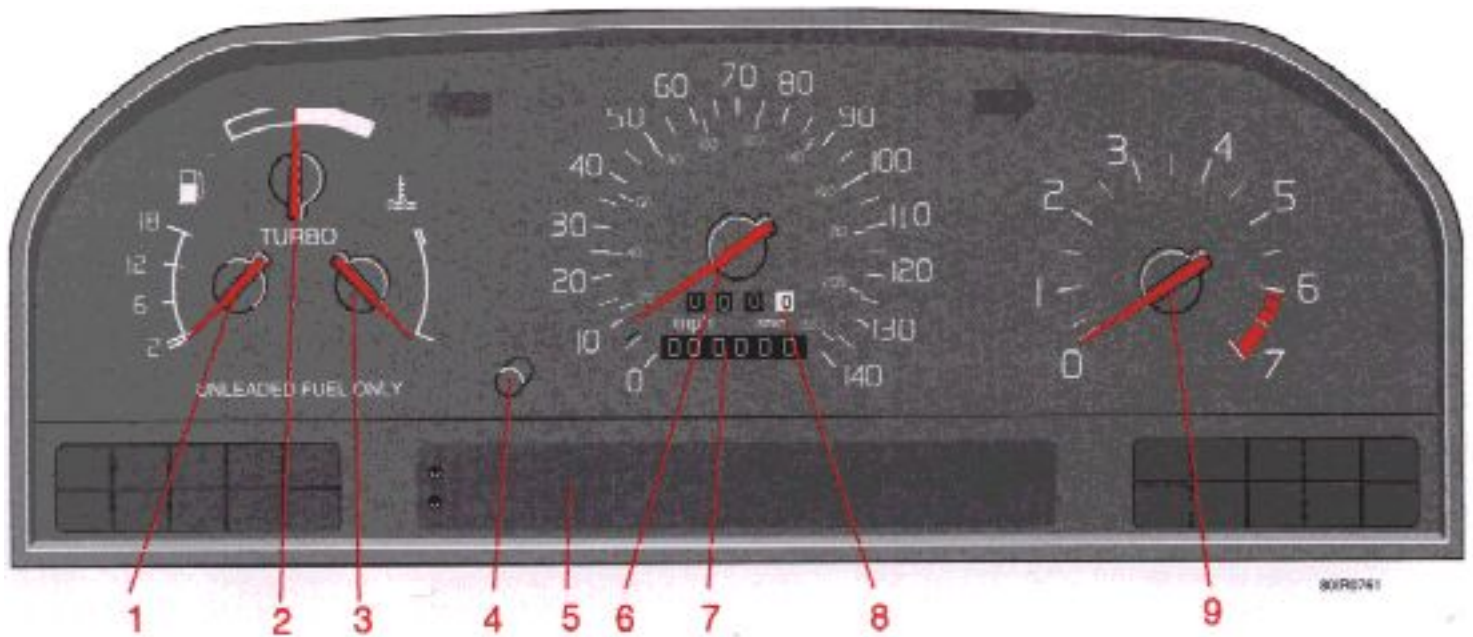

1 Fuel gauge

The fuel tank holds approximately 19.3 US gals. (73 liters). When the warning light comes on there is approximately 1.8 US gals. (8 liters) of fuel remaining. See "Refueling" for further information.

## 2 Boost pressure gauge

(Turbo models only)

The boost pressure gauge is divided into sections. **Black section:** The engine acts as a normally aspirated engine. Best fuel economy is achieved while driving in this range. **White section:** The turbocharger provides boost pressure.

## 3 Temperature gauge

The pointer should be approximately midway on the gauge face when driving. If the pointer approaches the red range repeatedly, check coolant level. Do not drive the car with the pointer in the red range. See "Coolant" section.

## 4 Trip odometer reset button

## 5 Clock, ambient temperature sensor (certain models), trip computer (certain models)

## 6 Speedometer

## 7 Odometer

## 8 Trip odometer

Used for measuring shorter distances. The last digit indicates 1/10 mile/kilometer. A black number on a white background = original speedometer. A red number on a white background = replacement speedometer.

## 9 Tachometer

Reads thousands of engine rpm. The engine should not be operated in the red range.

The highest permitted constant engine speed is 6,300 rpm (turbo-charged models: 6,200 rpm, B 5252 S: 6,000 rpm).

pg. 1:3 Indicator and warning lights

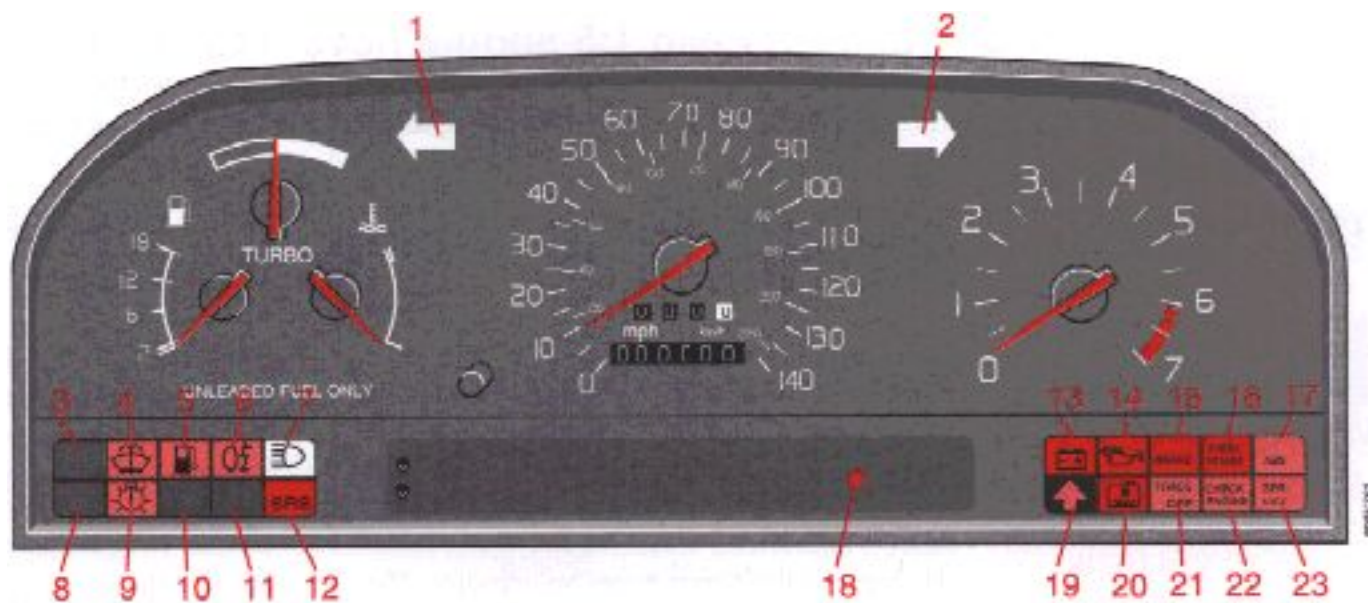

1 Turn signal, left

2 Turn signal, right

3 (Not in use)

4 Low washer fluid level

If the lamp glows continuously when the engine is running, there is only about 1/2 - 1 US qt. remaining in the washer fluid reservoir.

5 Low fuel level

When the lamp glows, only about 1.8 US gals. (8 liters) of fuel remain.

6 Rear fog light

7 High beams

8 (Not in use)

9 Bulb failure warning sensor

10 (Not in use)

11 (Not in use)

12 SRS

13 Generator not charging

14 Low engine oil pressure

15 Brake warning light

16 Parking brake applied



- 17 ABS-system
- 18 Ambient temperature warning light (certain models)  
(See pp. 1:11 or 1:14 for more information)
- 19 Transmission mode "W", or gear positions 3 or L engaged (automatic transmissions)
- 20 Low coolant level
- 21 Traction Control System (option)
- 22 Malfunction indicator lamp
- 23 Service reminder indicator

[pg. 1:4 Warning lights](#)

The warning lights described on pages 1:4 and 1:5 should never stay on when driving

When the ignition key is turned on and before the engine starts, all of the warning lights should be on to test the function of the bulbs. Should a light not go off after the engine has started, the system indicated should be inspected. However, the parking brake reminder light will not go off until the parking brake is fully released.



Generator warning light

If the light comes on while the engine is running, check the tension of the generator drive belt as soon as possible.



Malfunction indicator lamp

If the lamp comes on (or stays on after the vehicle has started), the engine diagnostic system has detected a possible fault in the emission control system. Although driveability may not be affected, see an authorized Volvo dealer as soon as possible for inspection.



Oil pressure warning light

If the light comes on while driving, the oil pressure is too low. Stop the car and then stop the engine immediately and check the engine oil level. See section "Engine oil". If the light stays on after restart, have the car towed to the nearest authorized Volvo dealer. After hard driving, the light may come on occasionally when the engine is idling. This is normal, provided it goes off when the engine speed is increased.



Parking brake reminder light

This light will be on when the parking brake (hand brake) is applied. The parking brake lever is situated between the front seats. Canadian models are equipped with this warning light: 



Brake fluid warning light

If the light comes on while driving or braking, this indicates that the brake fluid level is too low. Stop immediately, open the hood and check the brake fluid level in the reservoir (see section "Engine compartment" for reservoir position)! Canadian models are equipped with this warning light: 

#### WARNING!

If the fluid level is below the MIN mark in either section of the reservoir: DO NOT DRIVE. Tow the car to a Volvo dealer and have the brake system checked and any leakage repaired.

[pg. 1:5 Warning lights \(cont.\)](#)



TRACS warning light (option)

If this lamp comes on while driving, a fault is indicated in the TRAction Control System. It will also come on if the brakes are overheated and will go out when the brakes have cooled. If the lamp remains on, the system should be checked by an authorized Volvo dealer. This lamp should not be confused with the ON/OFF indicator lamp above the switch. See page 1:9 for additional information.

ABS

## Anti-lock Brake System (ABS)

If the warning lamp lights up there is a malfunction of the ABS system (the standard braking system will however function). The vehicle should be driven to a Volvo dealer for inspection.

See page 4:16 for additional information.

Canadian models are equipped with this warning light: 



## Coolant level sensor

If the light comes on while driving, the coolant level is low. The coolant level in the expansion tank should be checked immediately and topped up if necessary. The cooling system should be inspected by an authorized Volvo dealer.



## Mode "W" engaged

The lamp will light up when the Winter starting mode is engaged or if gears "3" or "L" are selected. If the warning lamp begins to flash, this means that there is a fault in the automatic gearbox. Contact your Volvo dealer.

SRS

## Supplemental Restraint System (SRS)

If the light comes on (or stays on after the vehicle has started), the SRS diagnostic system has detected a fault. Drive to an authorized Volvo dealer for an inspection of the system. See the SRS section for more information.

SER-  
VICE

## Service reminder indicator

This light will come on at 10,000 mile (16,000 km) intervals\*, after 750 hours of driving or after 12 months, whichever occurs first. It is a reminder to the driver that the service interval has been exceeded.

The light will stay on for 2 minutes after the start until reset by the servicing dealer.

\* Turbo-charged model intervals: 5,000 miles (8,000 km), 500 hours of driving or after 12 months, whichever occurs first.



### Bulb failure warning light

The light will come on if any of the following bulbs are defective:

- one of the low beam headlights
- one of the tail lights
- one of the brake lights when the brake pedal is depressed.

Check the fuse and bulb. See sections "Replacing bulbs" and "fuses".

Should the warning light come on after a defective outside bulb has been replaced, the corresponding bulb on the other side of the car should also be replaced.



[Contents](#) | [Top of Page](#)

pg. 1:11 Clock, Ambient temperature sensor (certain models)



### Resetting the clock

The digital clock can be reset by pressing one of the two buttons (A and B) with a pointed object such as the tip of a pen.

h = hours

m = minutes

Maintain the pressure on the buttons for more than four seconds to change the time more quickly.

### Ambient temperature sensor

This sensor indicates the temperature slightly above the road surface. A red warning lamp (C) lights up when the temperature is in the range of 23 - 36° F (-5 - +2° C). Please note that this lamp does not indicate a fault with your car.

At low speeds or when the car is not moving, the temperature readings may be slightly higher than the actual ambient temperature due to the heat generated by the engine.

### Display alternatives

If buttons A and B are pressed down simultaneously, it is possible to shift between four different display alternatives, as follows:

Press 1st time: 12 hour clock and °F

Press 2nd time: 24 hour clock and °F

Press 3rd time: 12 hour clock and °C

Press 4th time: 24 hour clock and °C

NOTE: If your battery has been disconnected, the display will default to the 24 hour clock and degrees centigrade.

pg. 1:12 Trip computer (certain models)



## Trip computer

The trip computer offers six functions which are presented in a single display. The cursor indicates the selected function. The trip computer's clock is shown permanently in the left-hand field. Refer to the previous page for more detailed information regarding the clock function.

The following data is monitored by the computer:

- Average speed
- Current fuel consumption
- Average fuel consumption
- Ambient temperature
- Tripmeter
- Driving distance on current fuel reserve

## Warning function

The trip computer is equipped with two warning functions:

- Low fuel level
- Low ambient temperature

If either of these situations occurs, the cursor is activated beside the function affected and in case of low ambient temperature, lamp A also lights up.\*

The relevant value is shown in the display, regardless of the function selected. In order to return to the selected function, the control should be rotated one step in either direction and then back again.

**NOTE:** The low ambient temperature warning always has the highest priority on the display panel.

\* See page 1:14.

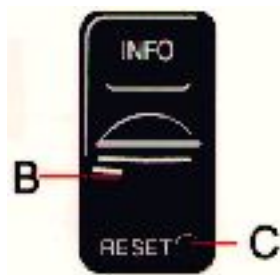

## Trip computer controls

Select one of the trip computer's six functions by using control B. The Reset button (C) is used to reset the following functions:

- Average speed
- Average fuel consumption
- Trip meter

Rotate the control to the required position and press the button for at least two seconds to reset the selected function.

NOTE: If pressure is maintained on the button for another three seconds, all three of the functions mentioned above will be reset.

[pg. 1:13 Trip computer \(certain models\) \(cont.\)](#)

## Average speed Ø mph (Canada: km/h)

Average speed since the function was last reset. When the ignition is switched off, the average speed is stored in memory and is used as the basis for the new figure when the engine is started again. It can be reset by pressing the reset button on the trip computer control.



## Current fuel consumption mpg (Canada: L/100 km)

Continuous information on current fuel consumption, calculated once per second. When the car is not moving, the display shows "---".

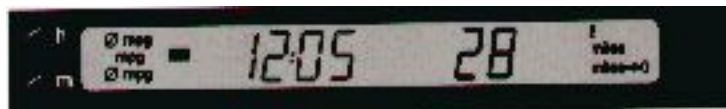

Average fuel consumption Ø mpg (Canada: L/100 km)

Average fuel consumption since the function was last reset. When the ignition is switched off, the average fuel consumption figure is stored in memory and remains in memory until it is reset using the button on the trip computer control.

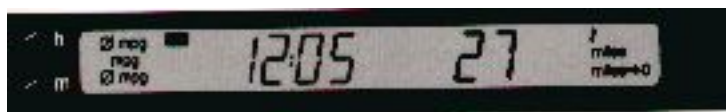

[pg. 1:14 Trip computer \(certain models\) \(cont.\)](#)

Ambient temperature

Shows the ambient temperature just above the road surface while driving. When the temperature is in the range 23 - 36° F (-5 - +2° C), the ambient temperature sensor activates an red warning light. Please note that this lamp does not indicate a fault with your car.

At low speeds or when the car is not moving, the temperature readings may be slightly higher than the actual ambient temperature due to the heat generated by the engine.



Tripmeter in miles (Canada: km)

Shows the distance driven since the function was last reset. This value is stored in memory until it is reset using the reset button on the trip computer control. The trip meter displays 10 yard intervals (Canada: 10 meters) until you have driven 1 mile (Canada: 1 km), after which distance will be measured in miles (km).





Driving distance on current fuel reserve  
mile 0 (Canada: km)

Shows the distance which can be driven on the fuel remaining in the tank, calculated on the basis of the average fuel consumption and the amount of fuel remaining in the tank at the time of the reading. When the quantity of fuel drops to below approximately 1.8 US gals. (8 liters), a warning light in the instrument panel comes on and the cursor beside the "Driving Distance on Current Fuel Reserve" symbol is activated. This takes place regardless of the function currently selected. When the driving distance on the current fuel reserve is less than 5 miles (8 km), the display shows "—".



[pg. 1:15 Cruise control](#)

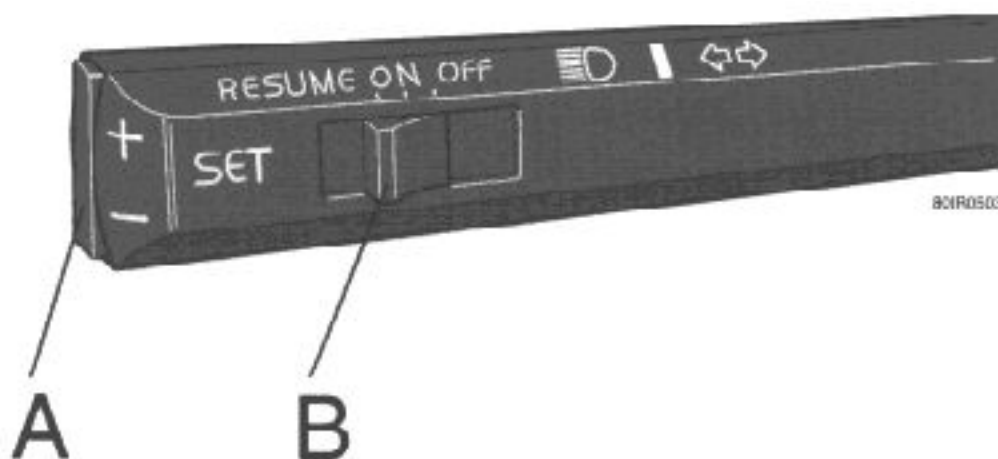

## Cruise control

The cruise control switches are located on the turn signal lever.

To engage and set the desired speed:

1. Set switch (B) to ON.
2. Accelerate to the desired cruise speed.
3. Press the + or - area of the SET button (A) to set the desired speed.

**NOTE:** The cruise control cannot be engaged at speeds below 22 mph (35 km).

## Braking

This will automatically disengage the cruise control. The previously selected cruise speed is retained in the memory and by momentarily setting the switch to the RESUME position, that speed will be re-engaged.

If the cruise control is already engaged, the cruising speed can be increased or decreased by depressing the SET button (A) towards either + or -. One short press on the button corresponds to a speed change of approx. 1 mph (1.6 km/h). When the button is released, the vehicle will maintain the current speed. If actual speed falls below 70% of the set speed or if the wheels spin or lock, the cruise control will disengage automatically.

## **NOTE: (AUTOMATIC TRANSMISSION)**

When driving up steep hills with the cruise control engaged, the transmission may shift intermittently.

This can be avoided by switching between transmission modes E or S while on the hill.

Normally, the ( E )conomy mode should be used when the cruise control is engaged.

## Acceleration

Momentary acceleration, such as for passing, does not interrupt cruise control operation. The previously selected speed will be maintained without having to set the switch to RESUME.

To disengage the cruise control system :

Set switch (B) to OFF, depress the brake pedal or move the gear selector to position N. Switching off the starting (ignition) switch will automatically disengage the cruise control system.

On cars equipped with manual transmissions, the cruise control can also be disengaged by depressing the clutch.

**WARNING!** The cruise control should not be used in heavy traffic or when driving on wet or slippery roads. Do not use or resume cruise control in reverse gear.

When the ignition is switched off, any information stored in the cruise control memory is erased.

[pg. 1:16 Heated front/rear seats \(certain models\)](#)

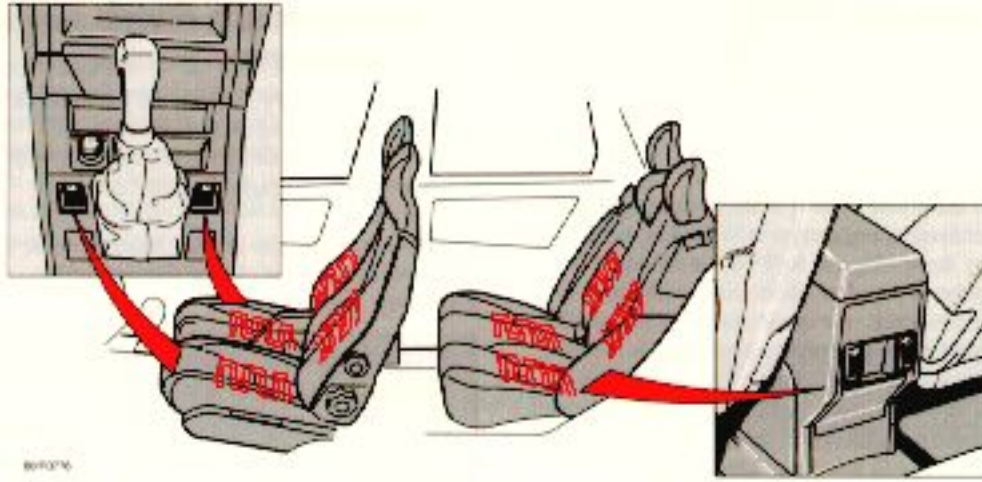

*Front seat controls      Rear seat controls*

### Heated front seats

The heated front seats can be switched on and off as required. When switched on, the system senses the ambient temperature and regulates the level of heat applied. When the optimum temperature is reached, the heating switches off automatically. While driving, the seat heating for the passenger seat should be switched off when the seat is not occupied.

### Heated rear seats

The rear seat heating can be switched on by pressing the button once. Press the button again to switch the heating off. If the heating is not switched off manually, a timer will automatically turn the system off after 10 minutes. The rear seat heating should be switched off when the seats are not occupied.

**NOTE:** The rear seat heating connector (located under the seat cushion) must be disconnected before the rear seat cushions can be removed.

[pg. 1:17 Parking brake, Cigarette lighter, Ashtrays](#)

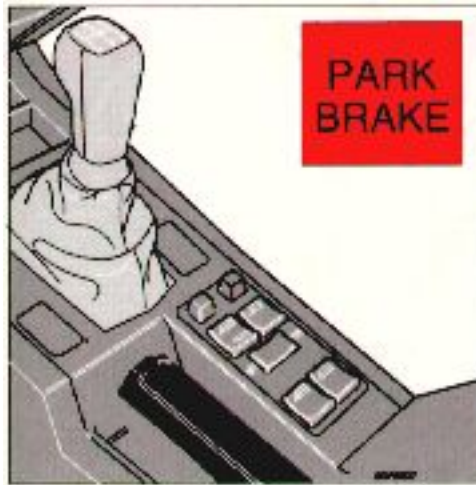

*Parking brake lever*

## Parking brake (hand brake)

The lever is situated between the front seats. The brake is applied to the rear wheels.

**WARNING!** Always use the parking brake (hand brake) when parking. On hills, also turn the front wheels toward the curb.

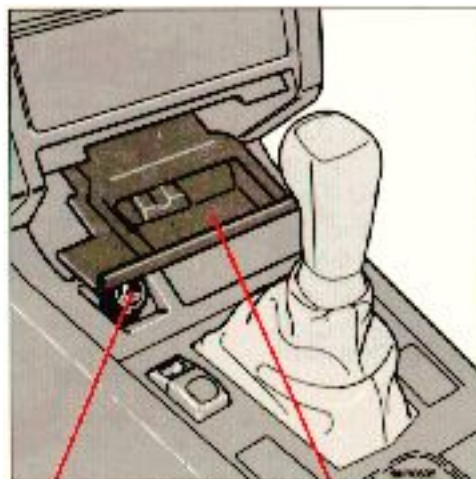

*Lighter \**

*Ash tray*

## Cigarette lighter

To operate, depress the knob fully. When the knob automatically releases, the cigarette lighter is ready for use.

The starting (ignition) switch must be either in position I or II for the cigarette lighter to function.

\* The cigarette lighter is located to the right of the gear shift lever on certain models. This is due to the placement of the "OBD II" terminal, a diagnostic connector intended for use by authorized service technicians only.

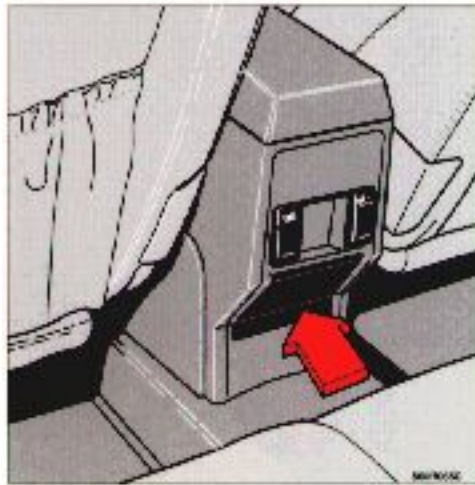

*Rear ash tray*

## Ash trays

To open the front ash tray, press lightly on the panel.

To open the rear ash tray, pull it straight out.

To empty the front ash tray (see illustration, center column):

(1) Grasp the removable gray insert on the sides and push it in.

(2) Pull the insert straight up.

Only this insert can be removed for cleaning.

To empty the rear ash tray, pull it out, lift up the rear edge and remove.

[pg. 1:18 Steering wheel adjustment](#)

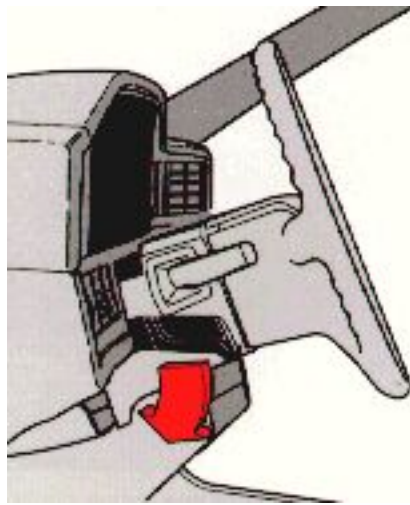

Depress...

## Steering wheel adjustment

Both the height and the reach of the steering wheel can be adjusted to a comfortable position for the driver. Press down the lever on the left of the steering column. Adjust the steering wheel to a suitable position and press the lever back into place to lock the steering wheel in the new position. Check that the steering wheel is locked in the new position.

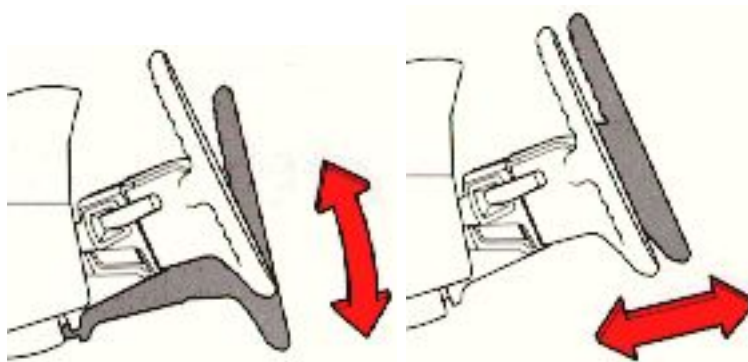

*... to adjust height*    *...to adjust length*

**WARNING!** Never adjust the steering wheel while driving.



[Contents](#) | [Top of Page](#)

## pg. 1:19 Heating, ventilation and air conditioning

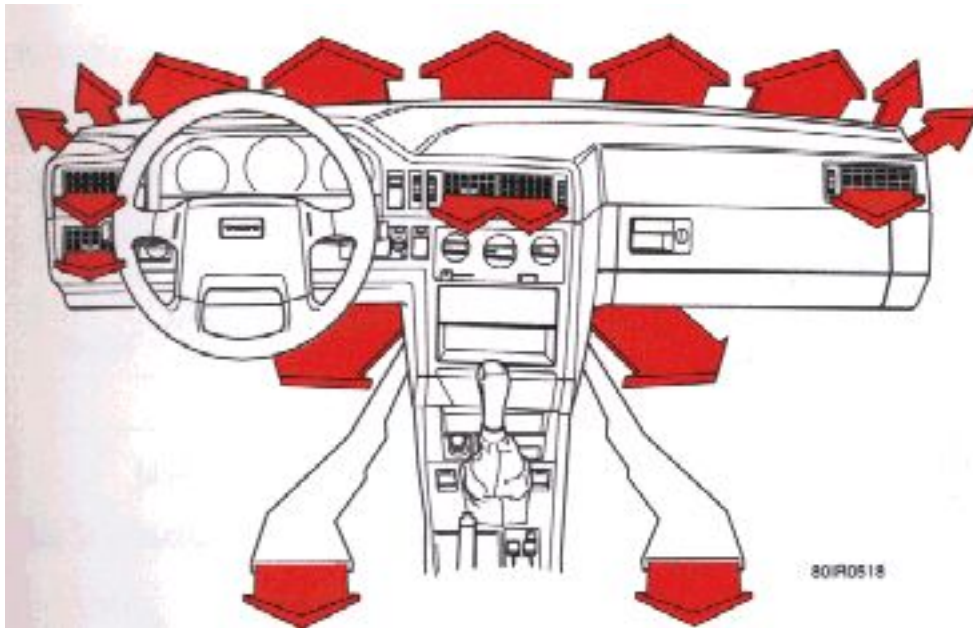

## Heating and air conditioning

Your Volvo is equipped with a heating system combined with air conditioning. Depending on which function you select, warm or cool/cold air is distributed to the different parts of the passenger compartment. A slight amount of condensation may be emitted from the air vents when the air conditioning is initially switched on. This can occur when both humidity and ambient temperature are high and is normal.

## Refrigerant

The air conditioning system in your car contains a CFC-free refrigerant - R134a. This substance will not deplete the ozone layer. Volvo cares about the environment. The system contains 1.65 lbs (0.75 kg) R134a and uses ZXL 100PG (type PAG) oil.

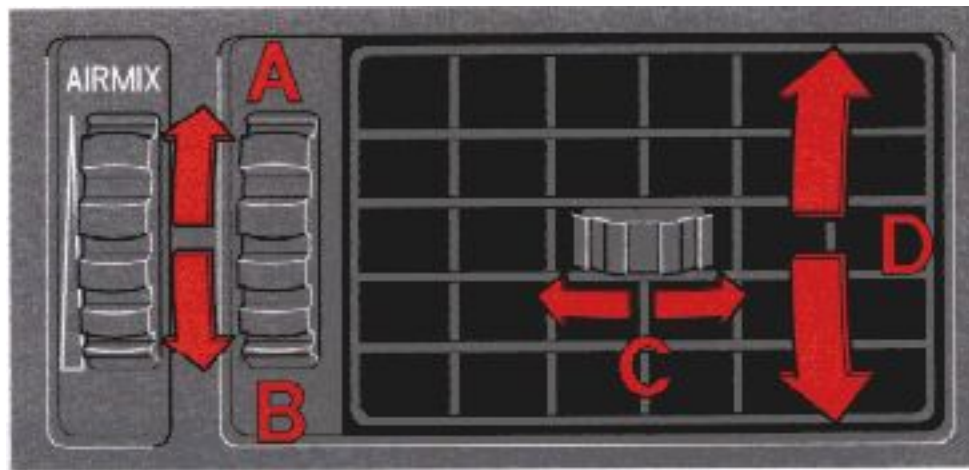

Air vents (dash)

A Closed

B Open

C Directing air flow horizontally

D Directing air flow vertically

Air mix

The center panel vents have an air mix function which allows fresh air to enter the passenger compartment when the vents are open (position B). This function is designed to allow you to direct cool air toward your face while directing warmer air to the rest of the passenger compartment. To warm the compartment as quickly as possible, the air mix control should be in the closed position.

pg. 1:20 Heating, ventilation and air conditioning (standard unit)





Temperature dial  
Driver's side  
Set desired temperature

Function selector  
Set desired function

Temperature dial  
Passenger's side  
Set desired temperature

Blower  
0 = Blower (and A/C) off  
4 = Highest blower speed

 Air in the passenger compartment recirculates - will not function in defrost setting. The light is ON when the function is engaged.



The A/C system is ON when the light is ON.

Function selector



Air through panel vents



Defrost. Air to windshield and side windows.



Air to floor, windshield and side windows.



Air through floor vents.



Bi-level. Air through floor and panel vents.

pg. 1:21 Heating, ventilation and air conditioning (standard unit) (cont.)

Maximum heating:



Close the center panel vents. When the passenger compartment has become sufficiently warm, set the blower control to position 2, adjust the temperature and open the side air vents.

Maximum cooling:

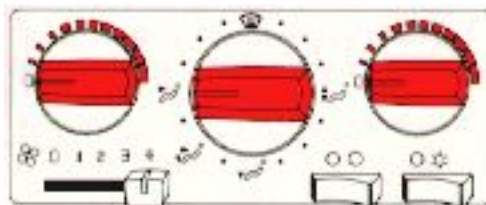

Open the vents. The A/C system should be ON.

Adjust the temperature with the temperature selectors to raise the temperature if necessary.

To demist/defrost the windows:



Set the function selector to . When the windows have cleared, set the blower control to position 2 and the function selector to the desired position. Always keep the air intake grille at the base of the windshield under the rear edge of the hood free of snow.

### Additional information

- The air conditioning system will function best if used regularly (at least once a month).
- Water under the vehicle in hot weather can be the result of condensation from the air conditioning system and is quite normal.
- The air conditioning system functions only at temperatures above 32° F (0° C).
-  Choose this position if the outside air is contaminated with exhaust gases, smoke, etc. or to heat/cool the car quickly. In this position, very little air is drawn into the passenger compartment from the outside. Do not leave the system in this mode for more than 10-15 minutes since the air inside the car will become stale. The temperature can be controlled with the temperature selectors.
- If the panel vents are open, a certain amount of air will always flow through, regardless of the position the function selector is in. To increase the flow of air to either the floor or the windows, close the panel vents. The outer vents can be opened to avoid mist on the side windows.
- The panel vents may emit some condensation when the air conditioning is initially switched on and is quite normal. This may occur if the ambient temperature and humidity are high.
- The air conditioning is momentarily disengaged during full-throttle acceleration.

pg. 1:22 Heating, ventilation and air conditioning (Electronic Climate Control) - option

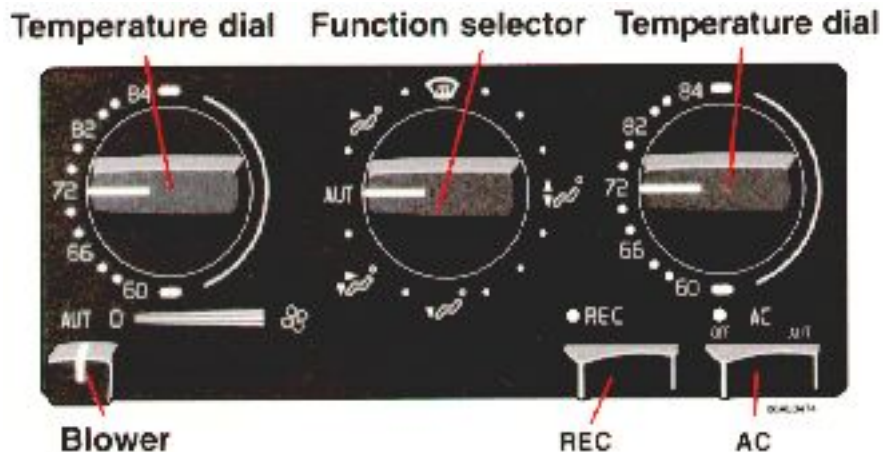

Temperature dial  
Driver's side  
Set desired temperature

Function selector  
Set desired function

Temperature dial  
Passenger's side  
Set desired temperature

Blower  
AUT=Blower speed automatically regulated.  
0 = OFF  
Move the knob to the right to increase blower speed.

REC  
Air in the passenger compartment recirculates - will not function in defrost setting. The light is ON when the function is engaged.

AC  
The light ON indicates that the A/C is OFF. When the function selector is in the defrost setting, the A/C system is ON regardless of the button position. The button must be in the AUT position for cooling.

Function selector

## AUT Air distribution automatically regulated



Air through panel vents



Defrost. Air to windshield and side windows. Recirculation will not function regardless of button position.



Air to floor, windshield and side windows.



Air through floor vents.



Bi-level. Air through floor and panel vents.

pg. 1:23 Heating, ventilation and air conditioning (Electronic Climate Control) - option (cont.)

## Automatic setting

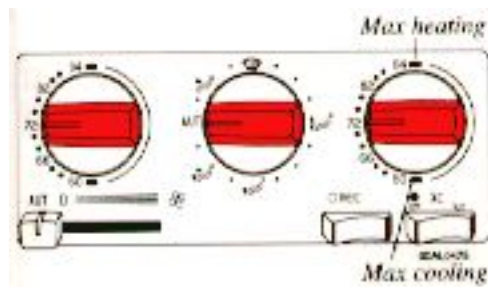

Set the mode selector to AUT and select the desired temperature. If the driver's side temperature selector is set to either the max heating or max cooling position, the blower will run at its maximum speed.

## Optimum defrosting



Set the function selector to  and move the blower control to the position AUT (as far to the left as

possible). The A/C system will be on at this time regardless of the A/C button's position and the blower will run at its maximum speed. When the windows have cleared, set the function selector in the AUT position.

### Additional information

- The air conditioning system will function best if used regularly (at least once a month).
- Always keep the air intake grille at the base of the windshield under the rear edge of the hood free of snow.
- Water under the vehicle in hot weather can be the result of condensation from the air conditioning system and is quite normal.
- The air conditioning is disengaged when the blower is set at 0 and the speed of the vehicle is less than 20 mph (30 km/h).
- The air conditioning system functions only at temperatures above 32° F (0° C).
- Recirculation (REC): Choose this position if the outside air is contaminated with exhaust gases, smoke, etc. or to heat/cool the car quickly. In this position, very little air is drawn into the passenger compartment from the outside. Do not leave the system in this mode for more than 10-15 minutes since the air inside the car will become stale and condensation will form on the windows.

NOTE: To help maintain stable passenger compartment temperature when driving with the sun roof or windows open, place the blower control in position "0" and adjust the desired temperature manually.

- If the panel vents are open, a certain amount of air will always flow through, regardless of the position the function dial is in. To increase the flow of air to either the floor or the windows, close the panel vents. The outer vents can be opened to avoid mist on the side windows.
- The panel vents may emit some condensation when the air conditioning is initially switched on and is quite normal.

This may occur if the ambient temperature and humidity are high.

- The sunlight sensor (located at the top center of the dashboard) should not be covered in any way as this could cause incorrect information to be sent to the ECC system.
- The air conditioning is momentarily disengaged during full-throttle acceleration.

### Faults in the ECC system

The REC and AC OFF lights will flash for approximately 20 seconds if a fault is detected in the ECC system.

If this flashing recurs the next time the system is switched on, the climate control unit should be checked

by an authorized Volvo dealer.

pg. 1:24 Electrically-operated windows

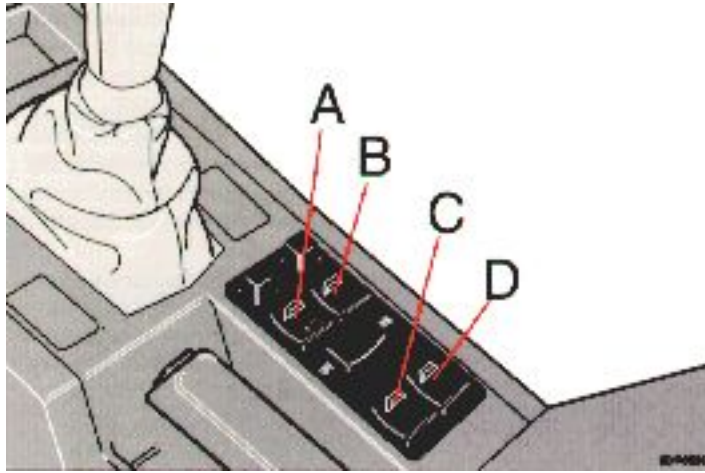

*A- Left front, B- right front, C- left rear, D- right rear*

### Electrically-operated windows

The electrically-operated windows are controlled by switches in the center console as shown in the illustration above. The starting (ignition) switch must be ON (position II) for the electrically-operated windows to function. The window is lowered if the rear part of the switch is pressed and raised if the front part of the switch is pressed.

**NOTE: Driver's window only (AUTO):** The window can be opened completely by pressing the rear part of the switch lightly and releasing it immediately. The window can be stopped by pressing the button again. If the button is held down, the window will be lowered until the button is released. The power window motors have an overload protecting circuit breaker which is activated when an object blocks a window. Should this occur, remove the object and wait 20 seconds for the circuit breaker to reset. The power windows should then function.

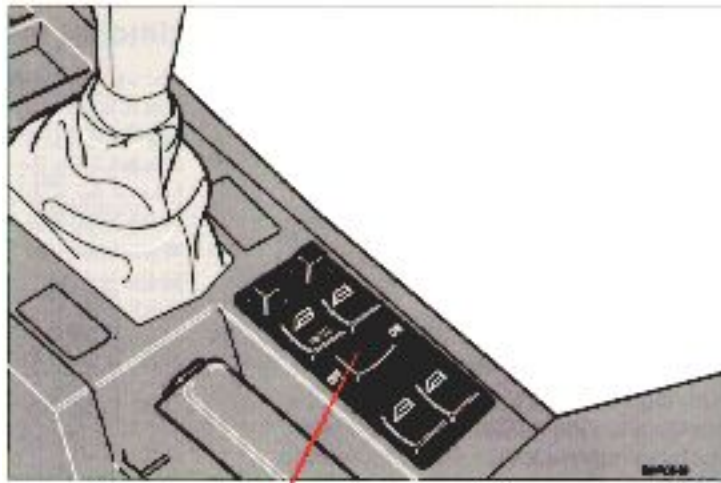

*Cut-out switch*

### Cut-out switch for electrically-operated rear-door windows

If the car is equipped with electrically-operated rear door windows, this function can be disabled by a switch located on the center console. This switch is positioned 90° in relation to the other switches.

**ON** The rear door windows can be raised or lowered with the respective door switches as well as with the switches on the center console.

**OFF** The rear door windows cannot be raised or lowered with the respective door switches but instead only with the corresponding switches on the center console.

**WARNING!** Remove the starting (ignition) key when children are left unattended in the vehicle.

Make sure that children's hands are clear before raising the windows.



[Contents](#) | [Top of Page](#)



## pg. 1:25 Audio system SC-710, general description

The following pages describe the use of your SC-710 Cassette Radio and CD remote control

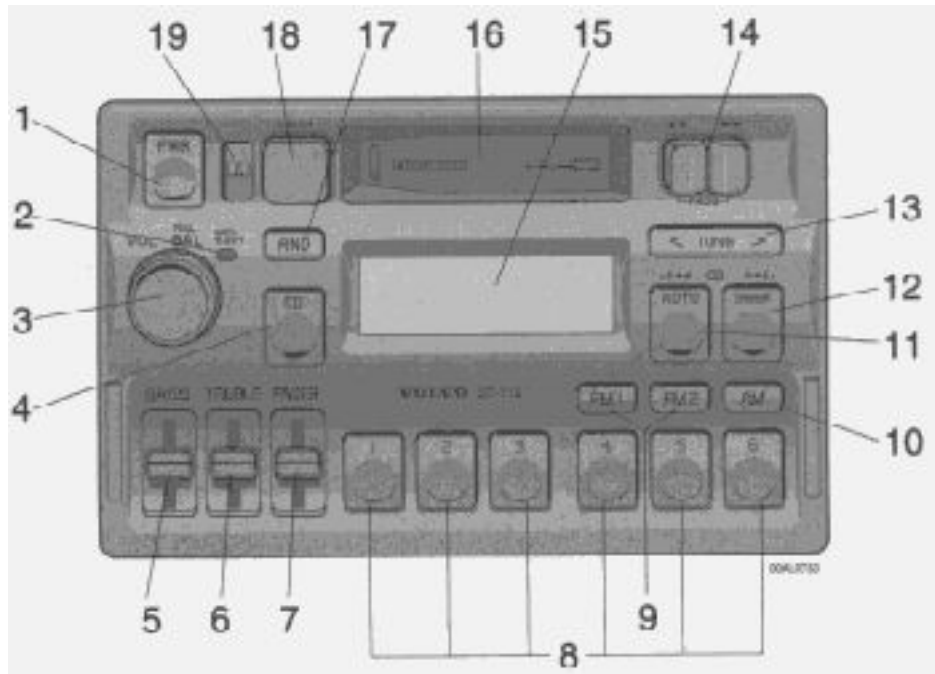

1. On/off (push)
2. Anti-theft LED
3. – Volume (turn)
- Balance (pull and turn)
4. CD mode selector
5. Bass control
6. Treble control
7. Fader control
8. – Preset buttons
- CD -Disc No. selector
9. Wave band selectors (FM)
10. Wave band selectors (AM)
11. – Auto seek memory
- CD - Previous track DOWN
12. – Seek tuning
- CD - Next track UP
13. – Manual tuning up/down
- CD - Music search DOWN
- CD - Music search UP

- 14. – Rewind / Forward
- Tape direction selector PROG
- 15. Display
- 16. Cassette slot
- 17. CD -Random play
- 18. Cassette eject
- 19. Dolby B button

CD = Applicable only when in CD mode and connected to a CD changer.

pg. 1:26 Anti-theft code - SC-710

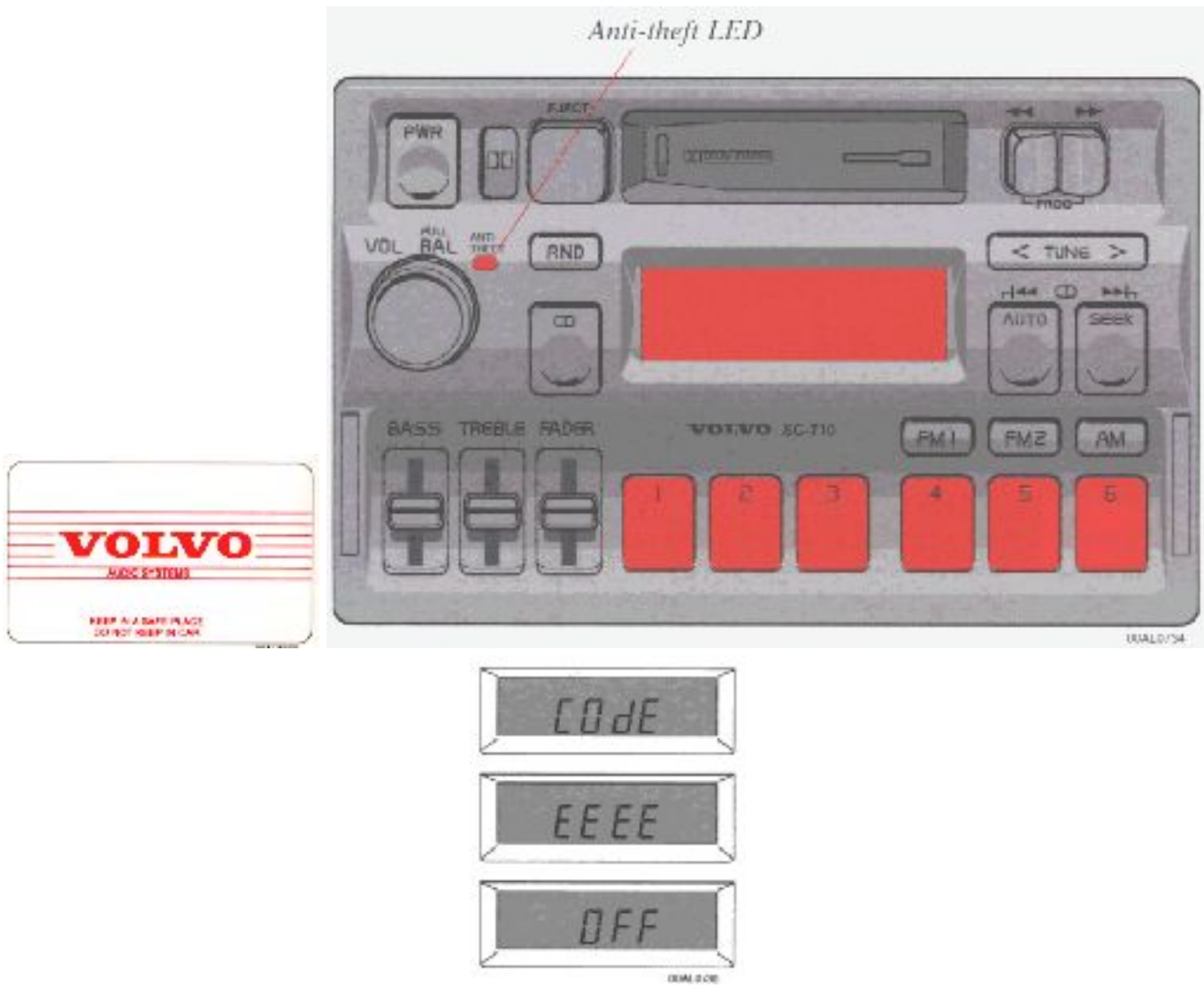

Anti-theft code

The radio features anti-theft circuitry. If the set is removed from the vehicle or if the battery power is disconnected, a special code must be entered to enable operation of the set. Refer to the radio code card supplied with your vehicle or ask your dealer for the correct code .

When the car is parked with the ignition key removed, the anti-theft LED will flash

To enter the code

After installation or when the set has been disconnected from power, the set displays "CODE" when it is switched on. Enter the 4-digit code using the preset buttons. If the correct code is entered, the set is ready to use. If you enter an incorrect code, you must enter the correct code again from the beginning.

Incorrect code

If an incorrect code has been entered, "EEEE" is displayed. Enter the correct code. After three unsuccessful coding attempts, the set will lock and remain locked for two hours. "OFF" is displayed. During this waiting period:

- The battery must be connected
- The ignition key must be turned to position I
- The unit must be turned on

Make sure the headlights are turned off to help prevent battery drain.

Enter the code again once this time has elapsed.

[pg. 1:27 Radio SC-710](#)

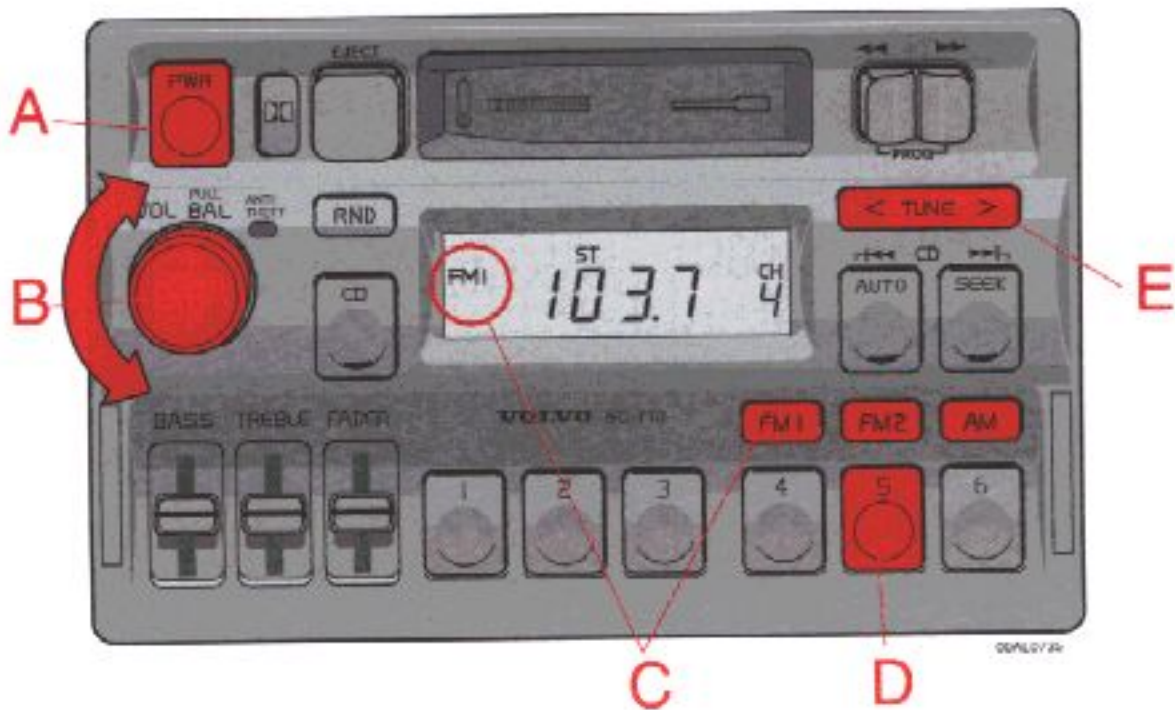

A - On/off switch

Push the button to switch on the radio.

B - Volume control

Turn the button clockwise to switch on and to increase the volume. The volume control is electronic and has no end stop.

C - Wave band selector

The desired wave band is set by pressing one of the wave band selector buttons. The frequency and wave band is shown on the display.

NOTE: There are two FM wave band and one AM wave band. This makes it possible to store 2 x 6 FM stations and 6 AM stations in memory.

D - Setting frequency selection

The radio can be used in most parts of the world by changing the frequency selection intervals as follows: Depress and hold preset button 5 and turn the radio ON. "USA" will flash on the display. Each time button 5 is pressed, the frequency selection will change from "USA" to "AUS", etc. When the correct country name is displayed, wait 5 seconds and the radio will be ready for use.

## E - Manual tuning

Press the left side of the tune button to tune to lower frequencies and the right side to tune to higher frequencies. The tuned frequency is displayed. ST will be displayed to indicate stereo FM reception.

pg. 1:28 Radio SC-710 (cont.)



## A - Seek tuning

Press the SEEK button to seek for higher frequencies. The radio seeks the next audible station and stops there. If you wish to continue the seek tuning, press the SEEK button again.

## B - Preset programming

1. Tune to the desired frequency.
2. Depress and hold a preset button. The audio will cut out. Keep the button depressed until the audio comes on again (approx. 2 seconds).
3. The frequency is now stored on this preset button.

## C - Preset buttons

To select a pre-programmed radio frequency, depress the preset button. The set frequency will be displayed.

pg. 1:29 Radio SC-710 (cont.)



## A - Automatic programming (Auto seek)

This function automatically seeks and stores up to 8 strong AM or FM stations. This is especially useful

when travelling in areas where radio stations are unfamiliar.

1. Depress and hold the "AUTO" button for at least 1 second (AUTO will be displayed). A number of strong stations (max. 8) on the chosen wave band are now automatically stored in the auto seek memory. If there are no audible stations, "----" is displayed.
2. Press the "AUTO" button (for less than 1 second) to obtain another autostored station. A new autostored station will be selected each time the button is pressed momentarily.

## B - Bass control

Adjust the bass by sliding the control up or down (up to increase, down to decrease). A "detent" indicates "equalized" bass.

## C - Treble control

Adjust the treble by sliding the control up or down (up to increase, down to decrease). A "detent" indicates "equalized" treble.

pg. 1:30 Radio SC-710 (cont.)



## A - Fader control

Adjust front/rear speaker balance by sliding the control up or down.

Up to direct more sound to the front speakers; down to direct more sound to the rear speakers.

The "detent" indicates "equalized" the front/rear balance position.

## B - Balance control

Pull out the "volume" knob and adjust the left/right balance by turning the knob counter-clockwise or clockwise.

The "detent" indicates "equalized" the left/right balance position.



[Contents](#) | [Top of Page](#)





#### A - Cassette slot

The cassette is inserted with the open side to the right (side 1 or A of the cassette upwards). When the cassette is inserted, the radio is disengaged and the cassette will start to play automatically. "TAPE ▶" or "TAPE ◀" is displayed to indicate which side of the tape is being played. When one side of the tape has been played, the unit will automatically play the other side (auto-reverse). The cassette can be inserted or ejected even when the unit is switched off.

#### B - Reversing the tape (PROG)

Press the two buttons to play the other side of the tape. The side of the tape being played will be displayed.

#### C - Fast winding

The tape is advanced with "▶▶" and rewind with "◀◀". Fast winding can be stopped by pressing the opposite button.

## D - Dolby B button

Press this button when you use tapes recorded with the Dolby B noise reduction system. The Dolby Symbol  will be indicated in the display.

[pg. 1:32 Cassette deck \(cont.\)](#)



## A - Cassette eject

If the button is pressed, the tape will stop and the cassette will be ejected. The radio or CD will engage automatically (depending on which mode was activated before the tape was played).

[pg. 1:33 CD - Remote \(certain models\)](#)

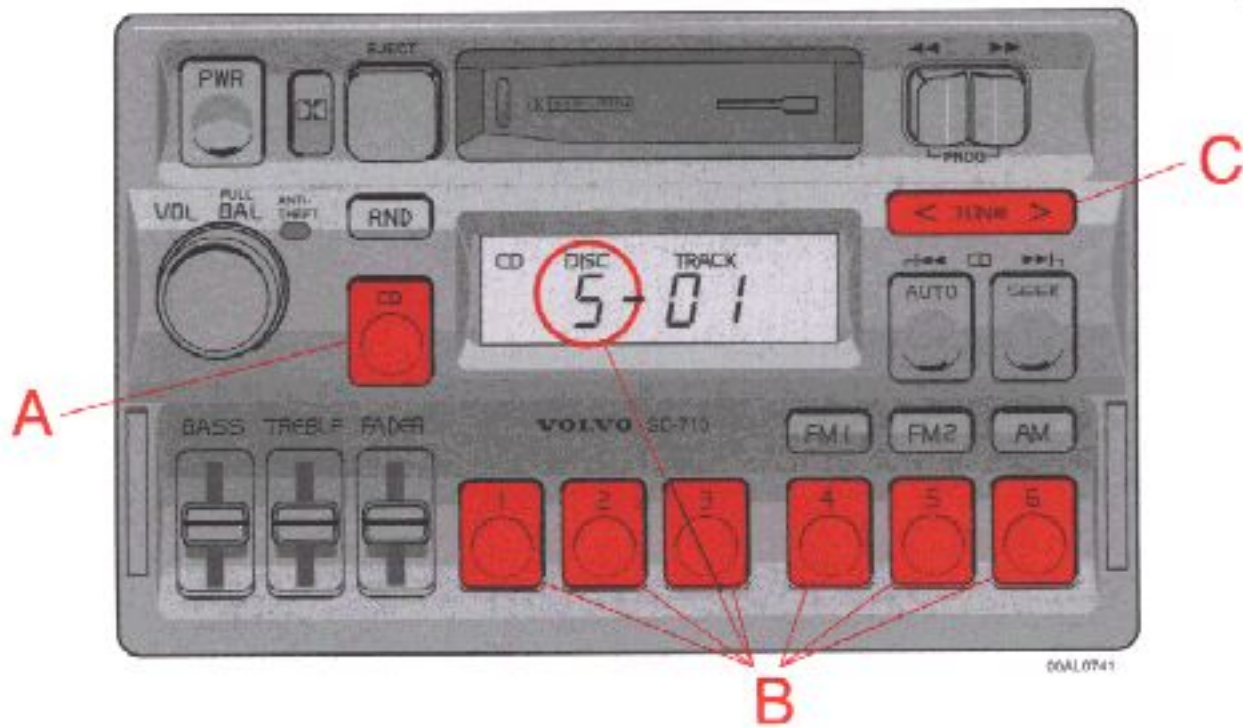

#### A - CD mode selector

Press "CD" to actuate the CD mode. The disc/track last listened to will continue to play. If the CD-changer cartridge\* is empty, "----" will be displayed. If a selected disc does not exist, the disc number and "5---" will be displayed and the next disc will be automatically selected.

\* The functions pertaining to the CD-changer are only applicable if the unit has been connected to the Volvo CD-changer which is sold separately as an accessory, or on certain models, standard on the car.

#### B - Disc number selector

Depress one of the preset buttons (1-6) to select the disc number desired. The selected disc number and track number will be displayed.

#### C - Music search

Press the TUNE button to search within a track. While the button is depressed the playing time for this track will be displayed.

## pg. 1:34 CD - Remote (certain models) (cont.)



## A - Changing the selected track number

Press CD  (SEEK) button to select the next track.

Press the CD  (AUTO) button to select the previous track.

The chosen disc number and track number will be displayed.

## B - Playing-time display

When the CD button is pressed, the playing time for the current track is displayed for 5 seconds.

## pg. 1:35 CD - Remote (certain models) (cont.)



#### A - Random choice

Press "RND" to actuate the random mode. From a disc chosen at random, 4 tracks will be played (also chosen at random).

A new disc will then be played in the same way. "RND" will be displayed when this function is engaged.

#### B - To re-enter Radio mode

To re-enter Radio mode, push one of the wave band selector buttons.

[pg. 1:36 Technical specifications](#)

#### SC-710

Output: 4 x 20 W (10% dist.)

Output impedance: 4 Ohms

System voltage: 12 Volts, negative ground

Fuse: 10 A

## Radio

System: PLL (Phase Lock Loop) system with tuned RF (Radio Frequency) front end and automatic wide band gain control. Electronic suppression circuitry (noise killer).

Frequency range:

FM 87.9 - 107.9 MHz

AM 530 - 1710 kHz

Sensitivity:

FM 1.3  $\mu$ V

AM 15  $\mu$ V

Stereo separation: 35 dB

Cassette deck 4 - track, 2 channel stereo

Tape speed: 4.76 cm/sec.

Channel separation 40 dB

Frequency range 30 - 15000 Hz

S/N (120  $\mu$ V) 50 dB

Wow and Flutter less than 0.06%

Pinch off

"Dolby" and the double D symbol  are the trademarks of Dolby Laboratories Licensing Corporation.

Dolby noise reduction is manufactured under license from Dolby Laboratories Licensing Corporation.



[Contents](#) | [Top of Page](#)

## pg. 1:37 Audio system SC-811, general description

The following pages describe the use of your SC-811 Cassette Radio and CD remote control



1. – On/off (turn)  
– Volume (turn)  
– Pause/Mute (push)  
– Balance (pull)
2. CD mode selector
3. Bass control
4. Treble control
5. Fader control
6. Waveband selectors (FM)
7. Waveband selectors (AM)
8. Preset buttons, CD-Disc No. selector
9. Auto seek memory (FM)
10. Dolby B button
11. – Manual tuning  
– Seek tuning (push)
12. Tape direction selector REV  
CD-Random play
13. Cassette eject
14. Display

15. Cassette slot
16. TP -Next song  
CD -Next track UP
17. TP -Fast forward  
CD -Music search UP
18. TP -Rewind  
CD -Music search DOWN
19. TP -Previous song REPEAT  
CD -Previous track DOWN
20. Tape mode selector

TP = Applicable only in tape mode

CD = Applicable only when in CD mode and connected to a CD changer

pg. 1:38 Anti-theft code



## Anti-theft code

The radio features anti-theft circuitry. If the set is removed from the vehicle or if the battery power is disconnected, a special code must be entered to enable operation of the set. Refer to the radio code card supplied with your vehicle or ask your retailer for the correct code .

When the car is parked with the ignition key removed, the anti-theft LED will flash

To enter the code



After installation or when the set has been disconnected from power, the set displays "codE" when it is switched on.

Enter the 4-digit code using the preset buttons. If the correct code is entered, "on" is displayed and the set is ready to use.

If you enter an incorrect code you must enter the correct code again from the beginning.

### Incorrect code

If an incorrect code has been entered "rPt" is displayed. Enter the correct code.

After three unsuccessful coding attempts the set will lock and remain locked for two hours. "OFF" is displayed.

During this waiting period:

- the battery must be connected
- the ignition key must be turned to position I
- the unit must be turned on

Make sure the headlights are turned off to help prevent battery drain. Enter the code again once this time has elapsed.

[pg. 1:39 Radio](#)

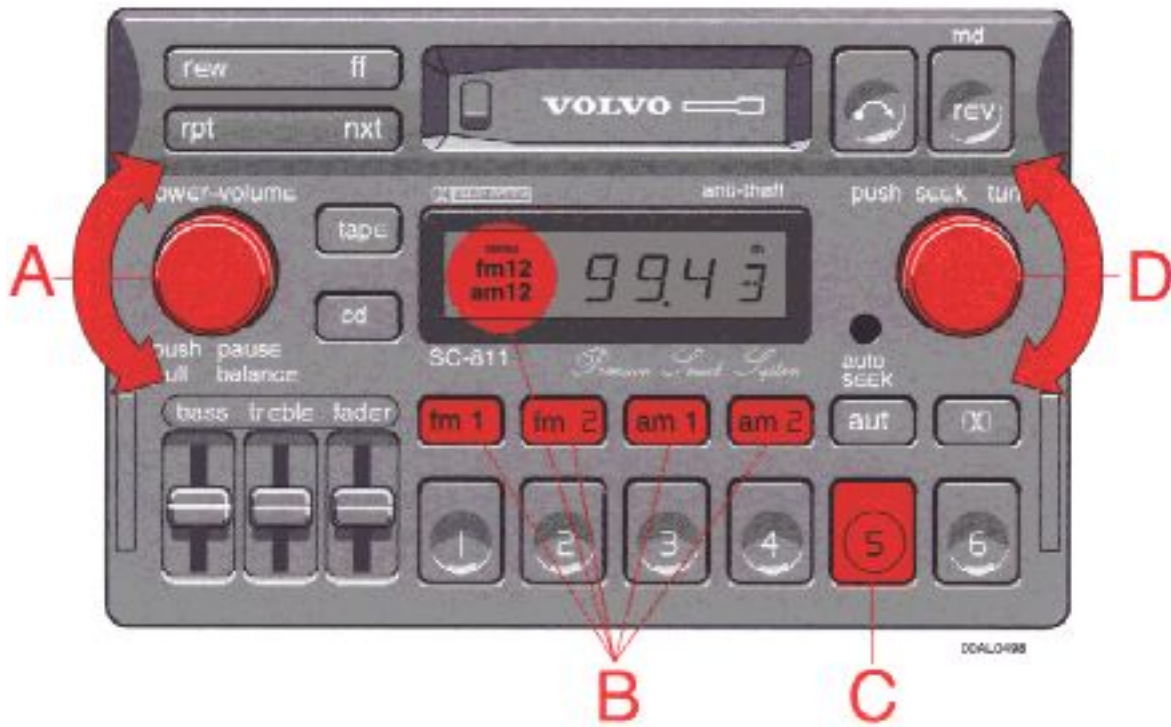

A - On/off switch and volume control

Turn the button clockwise to switch on and to increase the volume.

B - Waveband selector

The desired waveband is set by pressing one of the waveband selector buttons. The frequency and waveband is shown on the display.

NOTE: There are two FM wavebands and two AM wavebands. This makes it possible to store 2 x 6 FM stations and 2 x 6 AM stations in memory.

C - Setting frequency selection

The radio can be used in most parts of the world by changing the frequency selection intervals as follows:

Depress and hold preset button 5 and turn the radio ON. "USA" will flash on the display. Each time button 5 is pressed, the frequency selection will change from "USA" to "AUS", etc. When the correct

country name is displayed, wait 5 seconds and the radio will be ready for use.

When "USA" is chosen, the FM band will search for stations in 200 kHz intervals and AM will search in 10 kHz intervals.

## D - Manual tuning

Turn the knob counter-clockwise to tune to lower frequencies and clockwise to tune to higher frequencies. The tuned frequency is displayed.

pg. 1:40 Radio (cont.)

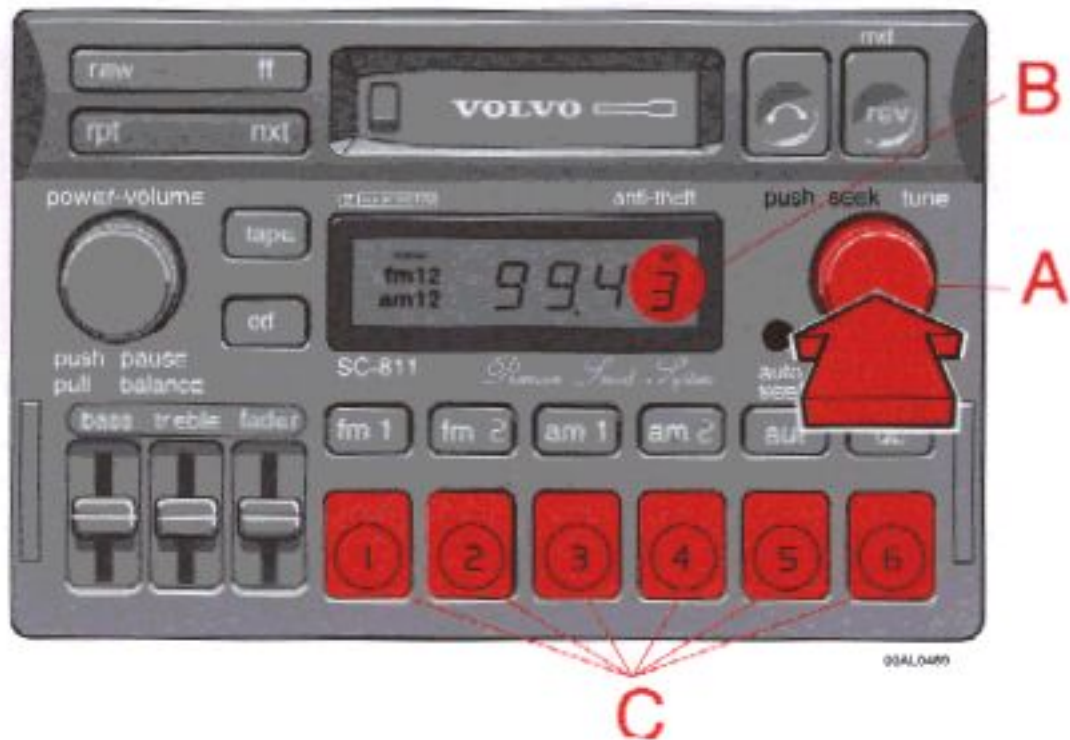

## A - Seek tuning

Push the tuning knob to seek for higher frequencies. The radio seeks the next audible station and stops there. If you wish to continue the seek tuning, press the tuning knob again.

## B - Preset programming

1. Tune to the desired frequency.
2. Depress and hold a preset button. The audio will cut out. Keep the button depressed until the audio comes on again (approx. 2 seconds).
3. The frequency is now stored on this preset button.

## C - Preset buttons

To select a pre-programmed radio frequency, depress the preset button. The set frequency will be displayed.

pg. 1:41 Radio (cont.)

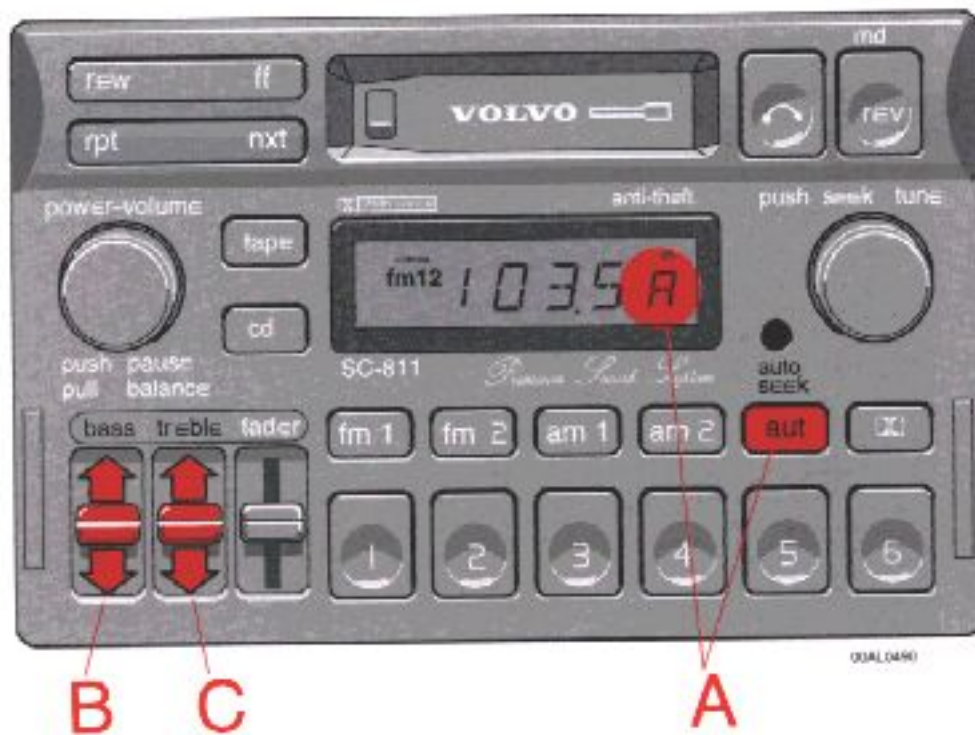

## A - Automatic programming (Auto seek)

This function automatically seeks and stores up to 8 strong AM or FM stations. This is especially useful when traveling in areas where radio stations are unfamiliar.

1. Depress and hold the "auto-seek" button for at least 1 second. A number of strong stations (max. 8) on

the chosen waveband are now automatically stored in the auto seek memory. If there are no audible stations, "no" is displayed.

2. Press the "auto seek" button (for less than 1 second) to obtain another autostored station. A new station will be selected each time the button is pressed.

### B - Bass control

Adjust the bass by sliding the control up or down (up to increase, down to decrease). A "detent" indicates "equalized" bass.

### C - Treble control

Adjust the treble by sliding the control up or down (up to increase, down to decrease). A "detent" indicates "equalized" treble.

pg. 1:42 Radio (cont.)



### A - Fader control

Adjust front/rear speaker balance by sliding the control up or down.  
(Up to direct more sound to the front speakers, down to direct more sound to the rear speakers).  
The "detent" indicates "equalized" front/rear balance position.

## B - Mute function

Press the "power-volume" knob to temporarily mute the sound. "PAUSE" is displayed.

## C - Balance control

Pull out the "volume" knob and adjust the left/right balance by turning the knob counter-clockwise or clockwise.



[Contents](#) | [Top of Page](#)



#### A - Cassette slot

The cassette is inserted with the open side to the right (side 1 or A of the cassette upwards). When the cassette is inserted, the radio is disengaged and the cassette will start to play automatically. "TAPE 1" or "TAPE 2" is displayed to indicate which side of the tape is being played. When one side of the tape has been played the unit will automatically play the other side (auto-reverse). The cassette can be inserted or ejected even when the unit is switched off.

#### B - Reversing the tape (rev)

Press the button to play the other side of the tape.  
The side of the tape being played will be displayed.

#### C - Fast winding

The tape is advanced with "ff" and rewind with "rew". The tape side indicator in the display will flash rapidly during fast winding. Fast winding can be stopped by pressing the button again.

## D - Dolby B button

Press this button when you use tapes recorded with the Dolby B noise reduction system. The Dolby Symbol  will be indicated in the display.

pg. 1:44 Cassette deck (cont.)



## A - "nxt" (next) selector

Press the "nxt" button and the tape will automatically advance to the next song. There must be a pause of approx. 5 seconds between songs for this function to operate.

## B - "rpt" (repeat) selector

Press the "rpt" button to rewind the tape to the beginning of the song. Press the button again to rewind to the beginning of the previous song.

There must be a pause of approx. 5 seconds between the songs for this function to operate.



## C - Pause

If you press the "power-volume" knob the tape is stopped, the unit is silent and "PAUSE" is displayed. To restart the tape press the knob again.

pg. 1:45 Cassette deck (cont.)

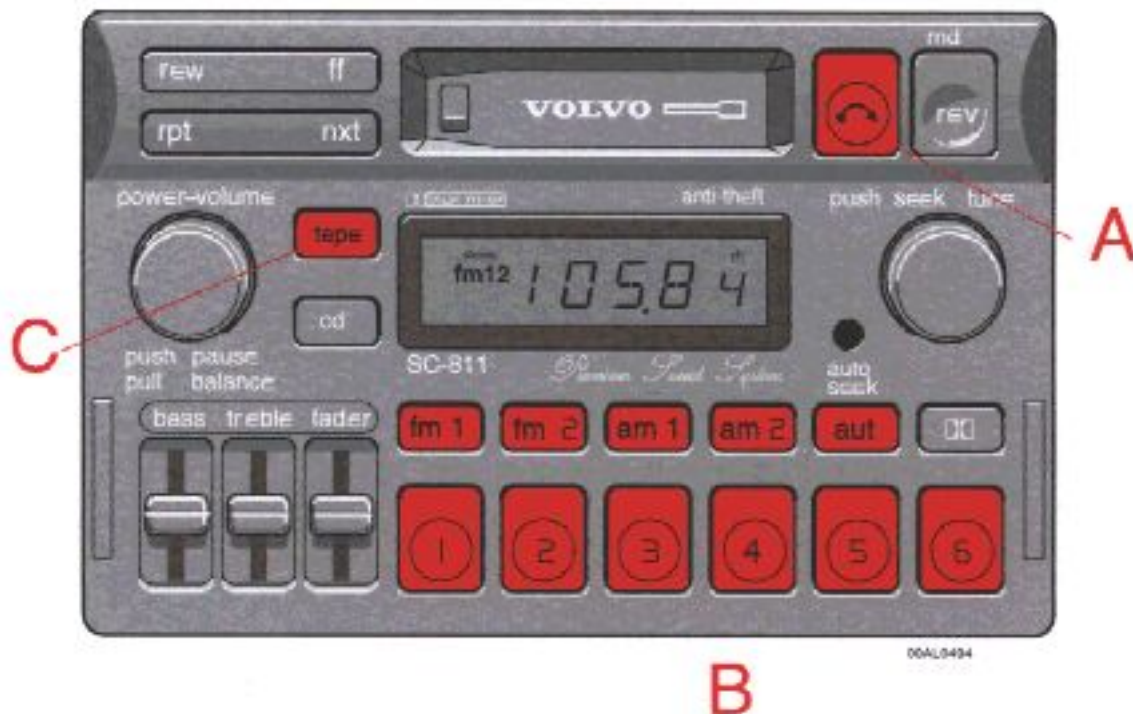

## A - Cassette eject

If the button is pressed the tape will stop and the cassette will be ejected. The radio will be automatically engaged. The radio or CD will engage automatically (depending on which mode was activated before the tape was played).

## B - To re-enter Radio mode

There are three alternative ways to re-enter Radio mode:

- Push one of the waveband selector buttons

- Push the auto seek button
- Push one of the preset buttons

When the unit re-enters Radio mode, the cassette will not be ejected.

C - To re-enter Tape mode

If the Tape function has been disconnected and the cassette has not been ejected, the Tape mode can re-entered by pressing the "tape" button.

pg. 1:46 CD - Remote (certain models)

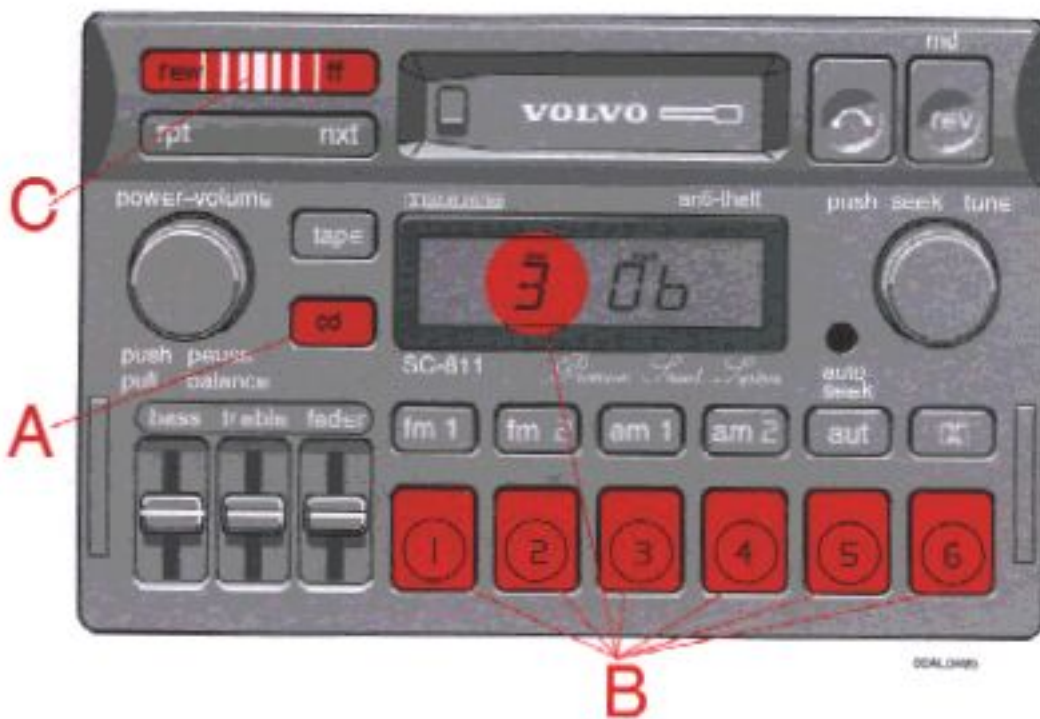

A - CD mode selector

Press "cd" to actuate the CD mode. The disc/track last listened to will continue to play. If the CD-changer cartridge\* is empty, "----" will be displayed.

If a selected disc does not exist, the disc number and "5--" will be displayed and the next disc will be automatically selected.

\* The functions pertaining to the CD-changer are only applicable if the unit has been connected to the Volvo CD-changer which is sold separately as an accessory.

### B - Disc number selector

Depress one of the preset buttons (1-6) to select the disc number desired. The selected disc number and track number will be displayed.

### C - Music search

Press the "rew" or "ff" button to search within a track. While the button is depressed the playing time for this track will be displayed.

[pg. 1:47 CD - Remote \(certain models\) \(cont.\)](#)



### A - Track number selector

Turn the knob to select the track number desired.

## B - Changing the selected track number

Press "nxt" for forward selection or "rpt" for backward selection. The chosen disc number and track number will be displayed.

## C - Playing-time display

When this button is pressed the playing time for the current track is displayed for 5 seconds.

[pg. 1:48 CD - Remote \(certain models\) \(cont.\)](#)



## A - Random choice

Press "rev" to actuate the random mode. From a disc chosen at random, 4 tracks will be played (also chosen at random). A new disc will then be played in the same way. "RND" will be displayed when this function is engaged.

## B - Pause

If you press the "power-volume" knob, the disc is stopped, the unit is silent and "PAUSE" is displayed. To restart the disc, press the knob again.

## C - To re-enter Radio mode

There are two ways to re-enter Radio mode:

- Push one of the waveband selector buttons
- Push the autostore button

## D - To re-enter Tape mode

If a cassette is already inserted, the tape deck will re-engage if the "tape" button is pressed.

[pg. 1:49 Technical specifications](#)

## SC-811

### Technical specifications

Output: 4 x 25 W (10% dist.)

Output impedance: 4 Ohms

System voltage: 12 Volts, negative ground

Radio System: PLL (Phase Lock Loop) system with tuned RF (Radio Frequency) front end and automatic wide band gain control. Electronic suppression circuitry (noise killer).

## Radio

Frequency range:

FM 87.9 - 107.9 MHz

AM 530 - 1710 kHz

Sensitivity:

FM 1.1  $\mu$ V

AM 20  $\mu$ V

Stereo separation: 35 dB

Cassette deck

4-track, 2 channel stereo

Full logic electronic control

Tape speed: 4.76 cm/sec.

Channel separation: 53dB

Frequency range: 30-15000 hz

S/N: 56 dB without Dolby B

S/N: 55 dB with Dolby B

Wow and Flutter: less than 0.06 %

"Dolby" and the double D symbol  are the trademarks of Dolby Laboratories Licensing Corporation.  
Dolby noise reduction is manufactured under license from Dolby Laboratories Licensing Corporation.



[Contents](#) | [Top of Page](#)

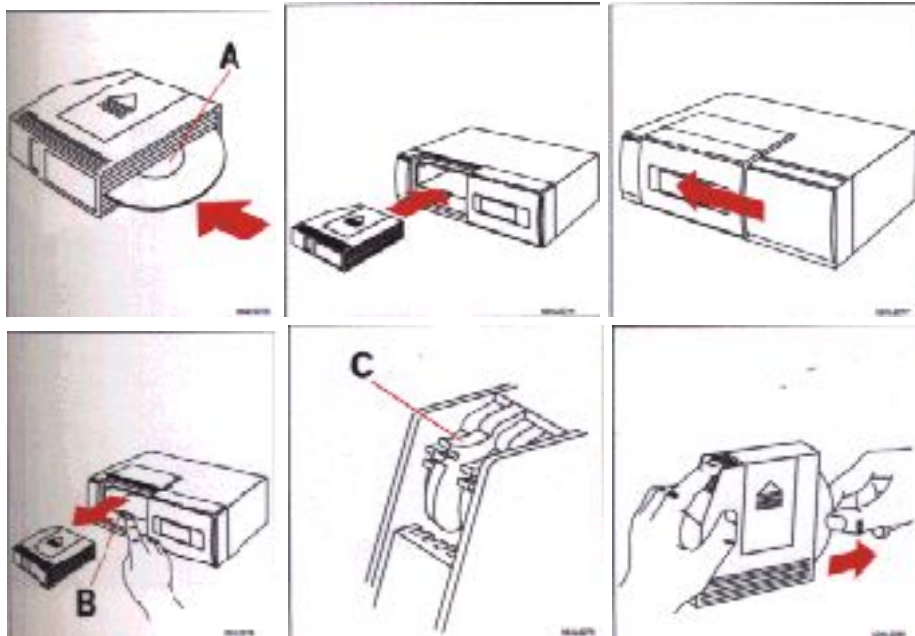

## CD remote changer

The CD changer, which is available separately, is loaded with a cartridge containing 6 discs. Extra cartridges are available at your Volvo dealer.

Insert the discs into the cartridge, label (A) up.

Insert the cartridge and close the cover.

Eject the cartridge by pressing the eject button (B).

Remove the discs by depressing the lock tabs (C).

## Operating tips:

- Before using a new disc for the first time, remove any burrs in the center/outer edge by running the stem of a pen or similar object around the hole/edge of the disc.
- Use high quality discs only.
- Keep the discs clean. Wipe them with a soft, clean, lint-free cloth, working from the center outwards. If necessary, dampen the cloth with a neutral soap solution. Dry thoroughly before using.
- Never use cleaning spray or anti-static liquid. Use only cleaners specifically made for CD's.
- Use discs of the correct size only (3.5" discs should never be used).
- Do not put tape or labels on the disc itself.
- Volvo does not recommend the use of plastic outer rings on the disc.

- Condensation may occur on discs/optical components of the changer in cold winter weather. The disc can be dried with a clean, lint-free cloth. Optical components in the CD changer may, however, take up to one hour to dry off.
- Never attempt to play a disc which is damaged in any way.
- When not in use, the discs should be stored in their covers. Avoid storing discs in excessive heat, direct sunlight or dusty locations.

[pg. 1:51 Audio systems, general information \(cont.\)](#)

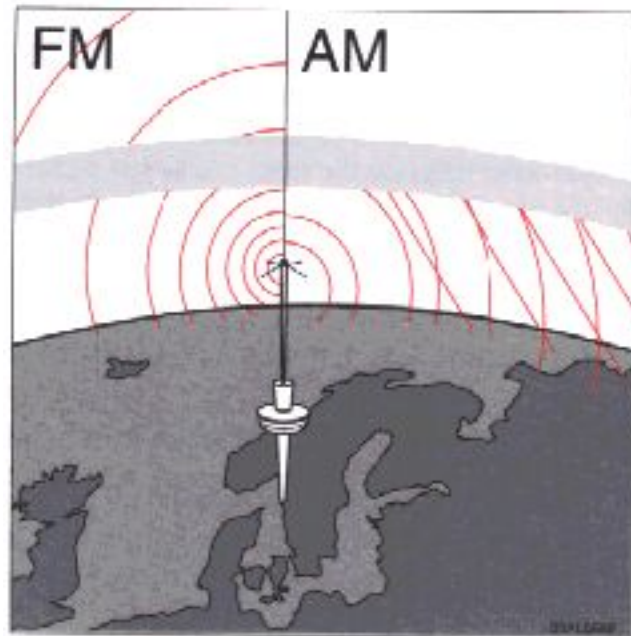

## Sending signals

The FM waves do not follow the earth's surface nor do they bounce off the atmosphere. For this reason their range is limited. The AM waves follow the earth's surface and reflect against the atmosphere, giving them a wide range.



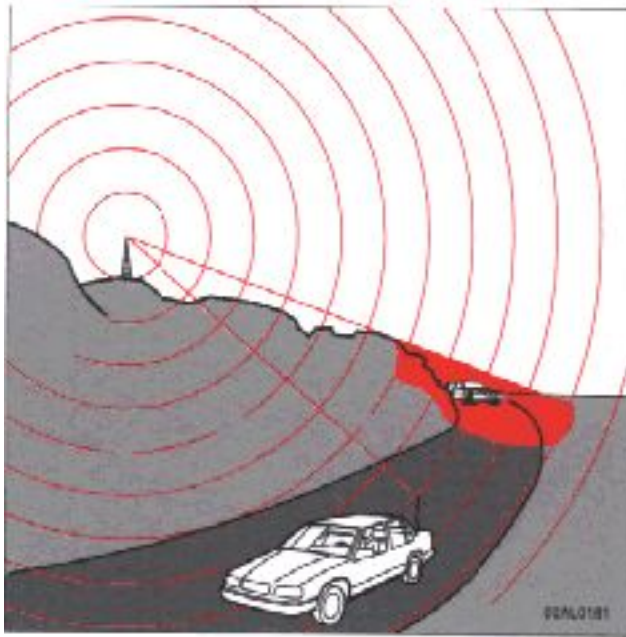

### Weak reception (fading)

Because of the limited range of the FM senders and the fact that these waves are very reflective, this problem usually occurs with FM reception. If the sender is blocked by buildings or mountains, static can result.

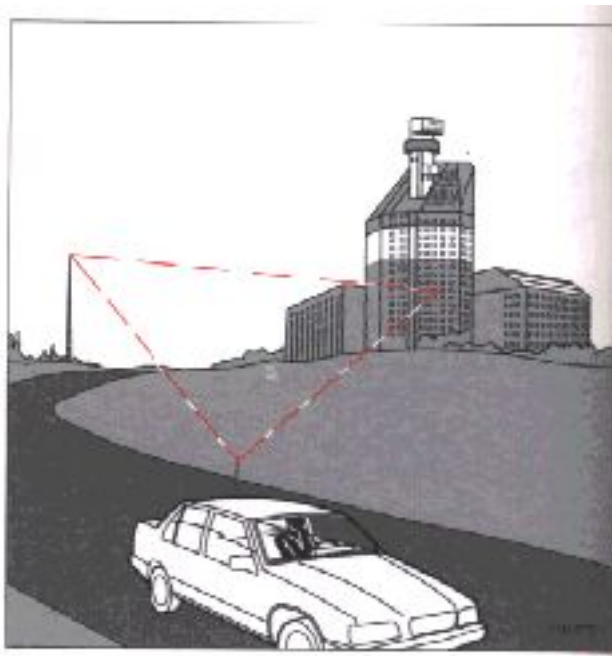

### Static

The reason why FM but not AM is audible in covered parking areas, under bridges, etc., is that FM

signals reflect against solid objects such as buildings. Because these waves are very reflective, static can result. This static is the result of the reflected signal and the direct signal reaching your antenna at slightly different times causing a cancellation of all signals. This problem occurs largely in built-up areas. To help minimize this situation, turn down the treble.

pg. 1:52 Audio systems, general information (cont.)

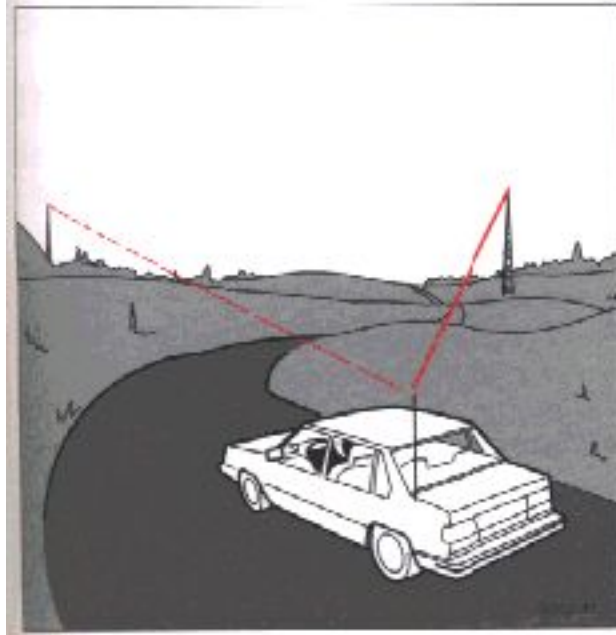

### Cross modulation

If you listen to a weak station in the vicinity of a stronger one, both stations may be received simultaneously.

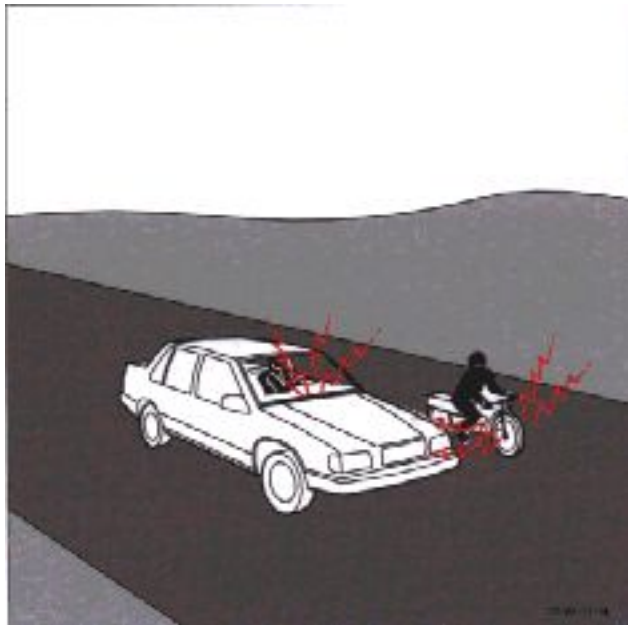

### FM - reasons for distortion

FM is affected by the electrical systems of nearby vehicles, especially those without suppression. The distortion increases if the station is weak or poorly set.

The FM reception is not as sensitive to electrical disturbances as AM.



### AM - reasons for distortion

AM reception is sensitive to electrical disturbances such as power lines, lighting, etc.

## FM stereo reception

Stereo reception places very high demands on the signal quality which means the type of distortions previously mentioned become even more obvious. The signal strength needs to be stronger for good stereo reception and this limits the effective range of the slender.

We hope that this information proves to be useful and provides you with a better understanding of the problems related to car radio reception.

Reception conditions are not always optimum and this is, of course, beyond our control. However, we have endeavored to make the Volvo Audio System of a quality that will enable you to enjoy the best possible reception no matter what the reception conditions may be.

## Radio antenna (sedans)

**NOTE:** Always lower the antenna when using an automatic car wash or entering a garage.

The antenna should be cleaned at least every 10,000 miles (16,000 km) or more frequently if needed. Use WD40 for cleaning.

Spray the antenna with WD40 and wipe it clean and dry with a rag. Spray it again. Lower and raise the antenna. Wipe it clean and dry again. Lower and raise the antenna 4-6 times. Make sure it is dry and free from dirt or lubricating oil.

## Radio antenna (wagons)

The radio antenna is built into the driver side window of the cargo area. This antenna also has a factory installed antenna booster.

**NOTE:** The antenna will not work without this booster.

Place objects in the cargo area so that the antenna wires on the inside of the window will not be damaged. When cleaning the window be careful that the wires are not scratched by rings, etc. If they are damaged, radio reception will be impaired.

## Cassettes

- Store cassettes in their cases.
- Do not touch the tape surface with your fingers.
- Tapes should not be exposed to direct sunlight or extreme temperatures.
- Keep tapes away from oil, grease and other contaminants.
- For optimal tape deck performance Volvo does not recommend the use of C-120 tapes.
- Take up slack using a pen or a pencil before inserting a cassette in the cassette slot.

## Cassette cleaning

We recommend the use of the Volvo Cleaning Cassette available as a genuine Volvo accessory. Regular use improves sound quality, cleans vital parts and prevents tape tangle.



[Contents](#) | [Top of Page](#)

pg. 1:6 Headlights, Parking lights, Turn signals

## Headlights and parking lights





O All lights off \*

 Parking lights on \*\*



Headlights and parking lights are on if starting (ignition) switch is in positions I or II.



If the headlight switch is in position  all lights will go out when starting switch is switched off.

With the headlight switch in position  the parking lights will stay on (headlights off) with the daytime running light screw (A) in position .

The high beams can only be switched on if the headlight switch is in position .

Switch from high to low beams and vice versa by moving the turn signal switch lever on the left side of the steering column towards the steering wheel.

\* Models equipped with daytime running lights: The low beams, tail lights, parking lights and license plate lights will come on automatically when the ignition is switched on.

\*\* The daytime running lights will also function when the headlight switch is in position  and the daytime running light screw (A) is in position .

For additional information on the daytime running lights, see page 1:8.

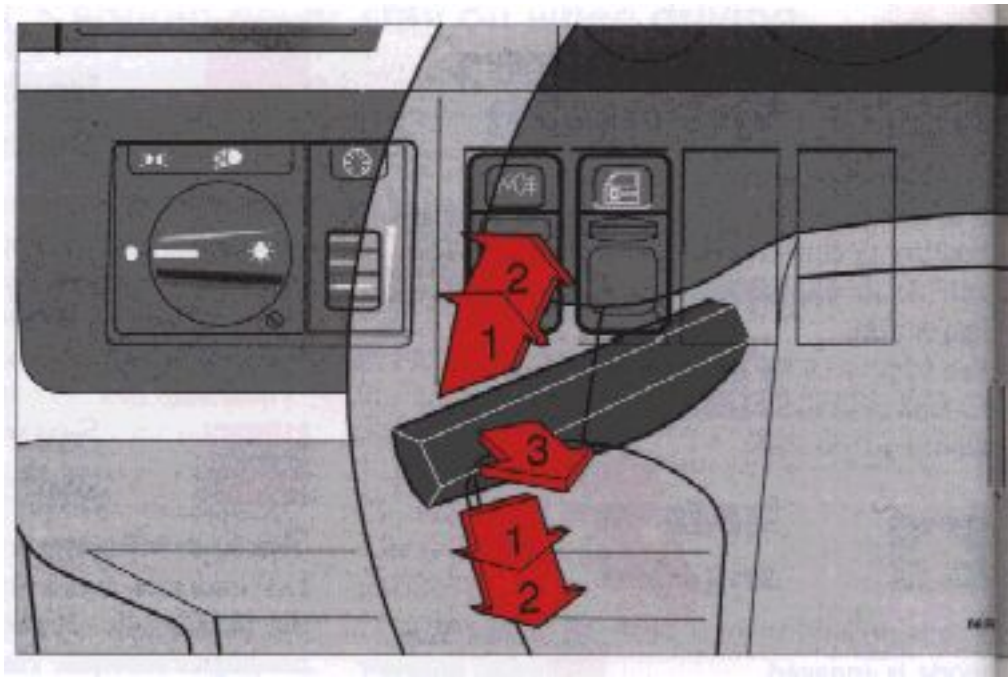

## Turn signals

1 Lane change position. In maneuvers such as lane changing, the driver can flash the turn signals by moving the turn signal lever to the first stop and holding it there. The lever will return to the neutral position when released.

2 Signal lever engaged for normal turns.

3 High beam/low beam switch (headlights on).

Move the lever towards the steering wheel and release it.

Headlight flasher (headlights off).

Move the lever towards the steering wheel. The headlight high beam will be on until the lever is released.

NOTE: A defective turn signal bulb will cause the turn signal indicator and remaining signal lights to flash more rapidly than normal.

[pg. 1:7 Windshield wipers/washers, Ignition switch](#)

## Windshield wiper/washer

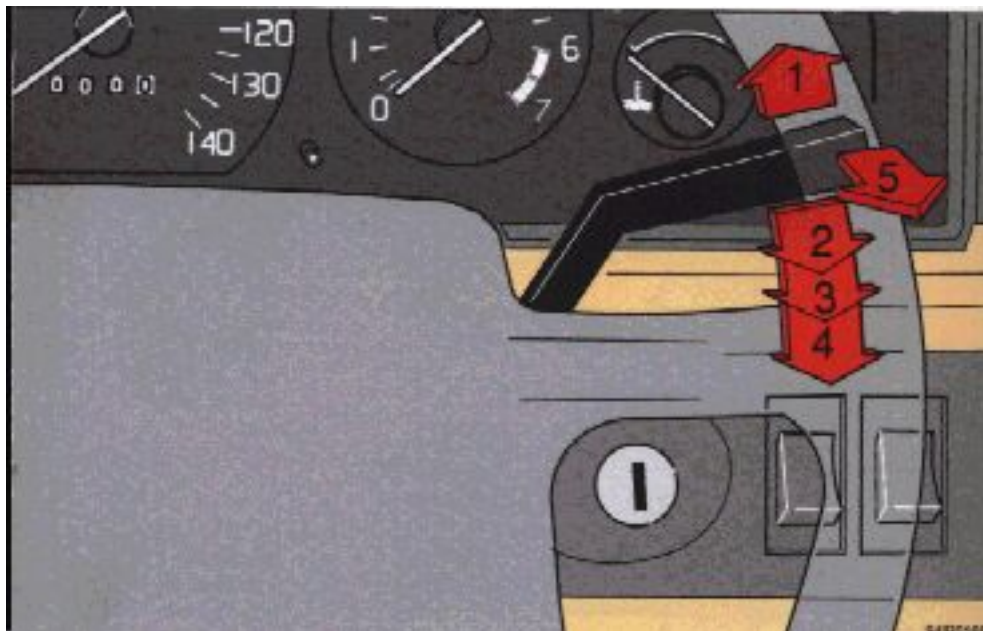

1 Intermittent wiper

With the switch in this position, the wipers will sweep approximately every seventh second.

2 "Single sweep" position:

The switch returns automatically when released.

3 Wipers, normal speed

4 Wipers, high speed

5 Windshield wiper/washer, headlight wiper/washer (certain models)

The wiper will make 2-3 complete sweeps across the windshield and headlights after the lever is released.

O Locked position:

Remove the key to lock the steering wheel\*

**WARNING:** Never turn the key to position O while driving or when the car is being towed.

I Intermediate position:

Certain accessories, etc. on

II Drive position:

Key position when engine is running.

III Starting position:

Release the key when the engine starts. The key returns automatically to driving position.

\* On cars equipped with an automatic transmission the gear selector must also be in the (P)ark position.



## Starting (ignition) switch/steering wheel lock

The steering wheel lock might be under tension when the car is parked. Turn the steering wheel slightly to free the ignition key.

In order to reduce car theft, make sure the steering wheel lock is engaged before leaving the car.

A chime will sound if the starting key is left in the ignition lock and the front door on the driver's side is opened.

pg. 1:8 Instrument illumination, Fog lights, Daytime running lights

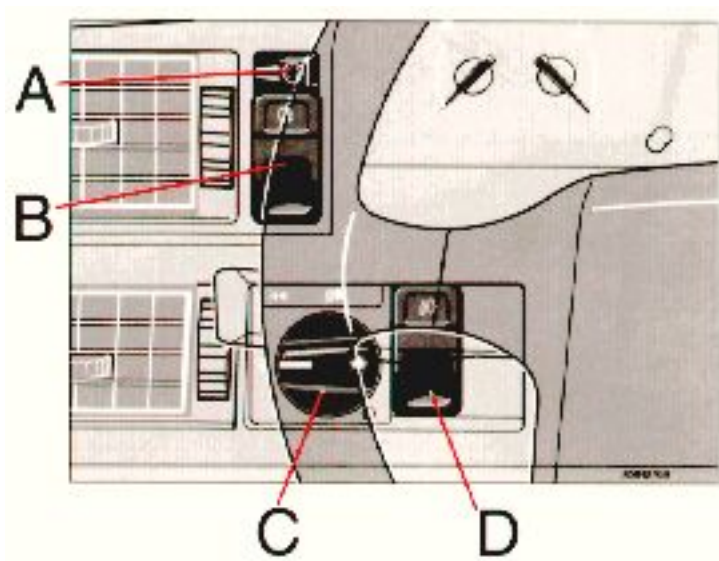

### A - Instrument illumination

To increase the brightness: move the slide switch to the right. To decrease the brightness: move the slide switch to the left.

### B - Rear foglight (one side only)

The rear foglight (located in the driver's side tail light cluster) is considerably brighter than the normal tail lights and should be used only when the atmospheric conditions, such as fog, rain, snow, smoke or dust reduce the daytime or nighttime visibility of other vehicles to less than 500 ft (150 meters).

For the rear fog light to function, the low beam headlights must be switched on.

## C - Automatic daytime running lights

NOTE: The daytime running light function may only be disabled (turned off) in the U.S. - Canadian law mandates the use of daytime running lights.

Screw A in the illustration (available on U.S. models only) is used to control the automatic daytime running lights when the headlight switch is in position 0.

To adjust, press in the screw with a small screwdriver and turn to one of the following positions:



- Automatic daytime running lights
- Automatic daytime running lights (will also function when the headlight switch is in position ~~30E~~)
- All lights off (daytime running light function disabled)

## D - Front fog lights (option)

The front fog lights, located in the front spoiler, will only function in combination with the low beam headlights.

[pg. 1:9 TRACS, Sun roof, Trip computer, Hazard warning flashers, Demister](#)

## A - TRAction Control System (TRACS) - option

TRACS is a system designed as an aid when starting/driving off if one of the drive wheels has poor traction due to weather conditions or the road surface and is connected to the ABS control module. TRACS is switched on manually with a button on the dashboard. The indicator lamp in the button will light up when the system is ON. With the button in the ON position, TRACS activates automatically if one of the front wheels loses traction, shifting power to the wheel with best traction.

A sound from the ABS control module may be audible at this time. The system functions only at speeds

under 25 mph (40 km/h).

## B - Electrically operated sun roof - option

The sun roof can be operated in two ways; as a conventional sliding roof or the rear edge can be raised to provide increased ventilation. See page 2:9 for operating instructions.

NOTE: In case of a sun roof malfunction, see page 6:17.

## C - Trip computer - option

Turn the dial to the desired function. For more information, see pages 1:12-14.

## D - Hazard warning flashers

The four-way flasher should be used to indicate that the vehicle has become a traffic hazard.

NOTE: Regulations regarding the use of the hazard warning flasher may vary from state to state.

## E - Rear window demister, heated side-view mirrors

Press the switch to start heating the rear window and side-view mirrors. The control light in the switch will illuminate.

A timer switches off the system after approximately 12 minutes. The control light will go out correspondingly.

[pg. 1:10 Tailgate wiper/washer \(wagons\)](#)

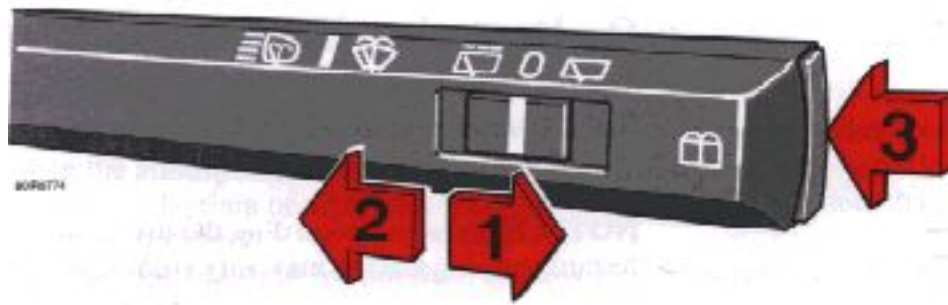

## Tailgate wiper/washer (wagons)

Tailgate window wiper/washer The tailgate window wiper/washer is operated by a switch at the end of the wiper level.

1. The wiper operates continuously.
2. Intermittent position: the wiper strokes approximately every 10 seconds.
3. Tailgate washer (note that the wiper also operates when this button is depressed): after the button is released the wiper strokes 2-3 additional times before stopping.



[Contents](#) | [Top of Page](#)

## Body and interior

pg. 2:1 Body and interior

### Body and interior

The seats, sun roof, mirrors, etc. are described on the following pages.

- [2:2](#) Keys
- [2:3](#) Doors and locks
- [2:4](#) Remote keyless entry system
- [2:5](#) Alarm
- [2:6-7](#) Front seats
- [2:7](#) Rear/side view mirrors
- [2:8](#) Interior lights, Vanity mirror
- [2:9](#) Sun roof
- [2:10](#) Hood
- [2:11](#) Storage compartments
- [2:12](#) Child safety locks, Trunk lid
- [2:13](#) Tailgate, Child safety lock
- [2:14](#) Trunk light, Spare tire, Jack
- [2:15](#) Cargo space lighting, Spare tire, Jack (wagon)
- [2:16](#) Folding rear seat (sedan)
- [2:17](#) Folding rear seat (wagon)
- [2:18](#) Removing seat cushions, Concealed storage bins (wagon)
- [2:19](#) Luggage cover
- [2:20](#) Luggage net (wagon)
- [2:21](#) Securing cargo
- [2:22](#) Folding front seat, Long load storage

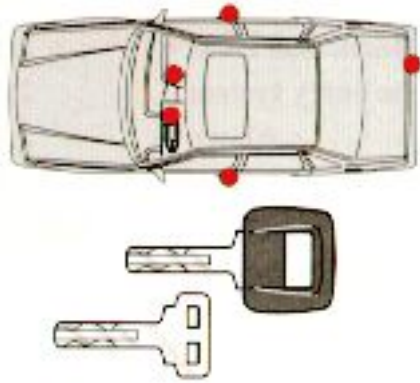

### Master key and wallet key

These keys operate all locks

The key number codes are stamped on a separate tag supplied with the keys. This tag should be separated from the key ring and kept in a safe place.

An added anti-theft measure, new keys have been developed which may take slightly longer to copy or replace if the original keys are misplaced.

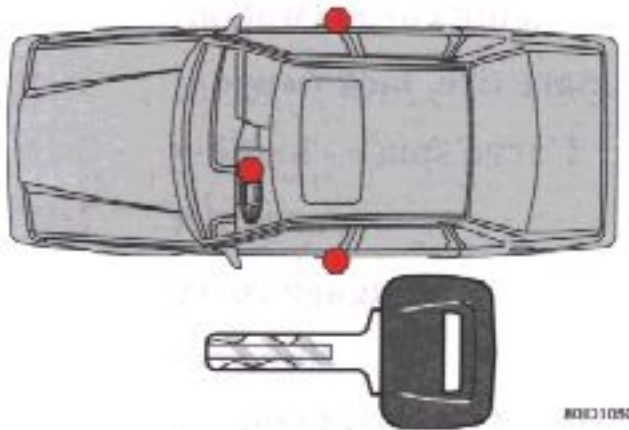

### Service key

Front doors, starting (ignition) switch/steering wheel lock

In the event the original keys are lost, duplicates may be ordered from your Volvo retailer. The central locking system is described in detail in the section "Doors and locks".



## Number tag

[pg. 2:3 Doors and Locks](#)



## Doors and locks

Your car is equipped with a central locking system. This means that all of the doors (including the trunk lid/tailgate and fuel tank flap) can be locked or unlocked from either of the front doors or the trunk lid/tailgate. If the driver/passenger door or trunk lid/tailgate is locked or unlocked using the key, the other doors will also be locked or unlocked automatically. To lock or unlock the car from the inside, push or pull the lock buttons on either of the front doors. If either of the front doors is opened from the inside, all of the doors and trunk lid/tailgate will be unlocked.

**WARNING!** The lock button should not be in the down position while driving. In case of an accident, this may hinder rapid access to the occupants of the vehicle. (Also see information on "Child safety locks").

Check the action of the buttons on the other doors to verify their correct function (lock/unlock). The driver's door can be locked only by using the key when outside the vehicle. On vehicles equipped with the optional remote control locking system, refer to the following page.

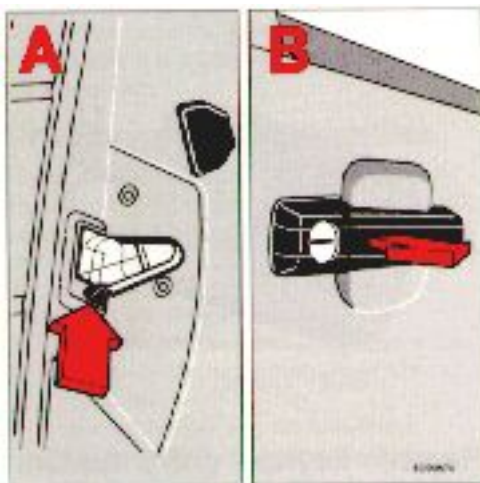

To avoid battery drain.

The courtesy lights and the warning lights in the rear of the doors come on when a door is opened. To avoid battery drain when the doors are opened for prolonged periods, these lights can be switched off by pressing the lock mechanism (A) located in the rear facing side of the driver's door. To return the lights to their normal function, pull the door handle out before closing the door (B).

[pg. 2:4 Remote keyless entry system \(certain models\)](#)





## Remote keyless entry system

As an option, your car can be equipped with a remote control transmitter. This transmitter uses a radio frequency which will allow "keyless" entry into the passenger compartment or the trunk. You will be supplied with two coded key ring transmitters, which will enable you to lock/unlock all doors and the trunk/tailgate from a distance of 10-15 feet (3-5 meters). To operate the system press either the LOCK or UNLOCK button. On vehicles equipped with an alarm, the alarm will also be activated/deactivated by this system.

This device complies with the FCC rules Part 15. Operation is subject to the following two conditions: (1) This device may not cause harmful interference and (2) this device must accept any interference that may be received, including interference that may cause undesired operation.

**WARNING!** Volvo does not recommend using the transmitter to lock the doors from inside the car. On cars equipped with an alarm, the alarm would be activated and would sound when one of the doors is opened. However, as a safety feature, the doors and trunk/tailgate can be unlocked if the starting (ignition) key is in position I or II. The remote keyless entry system will not function when the ignition is on.

The doors must not be locked using the remote transmitter while the vehicle is occupied. In case of an accident, this may hinder rapid access to the occupants of the vehicle. The alarm will also sound on models equipped with this feature.

As an anti-theft precaution, the transmitter should NOT be left with the keys when the car is brought to a workshop for service/repairs. If one of the transmitters is misplaced, contact the nearest authorized Volvo dealer for assistance.



## Battery replacement

If you have to stand closer to the car than normal to operate the system, this is a good indication that the battery should be replaced.

To replace the battery:

Remove the cover on the back of the transmitter with a coin.

Replace the battery (type CR2025). The new battery should be put in with the text side up so that the cover can be closed. Install the battery cover again, making sure it is on tightly to help prevent water from entering the transmitter.

[pg. 2:5 Alarm](#)

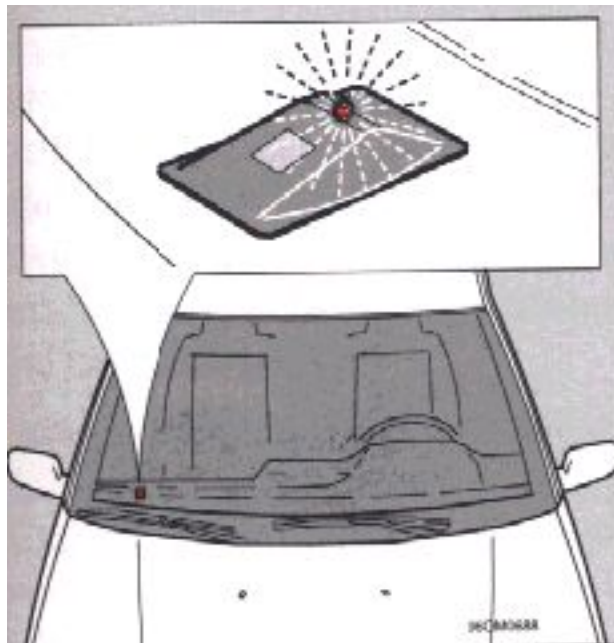

## Alarm (certain models)

As an option, your car may be equipped with an alarm.

The alarm system is connected to the doors, hood, trunk/tailgate and the starting (ignition) switch. The alarm can be deactivated by turning the key in either of the front door locks or the trunk/tailgate. A red LED flashed on the top-center section of the dash to indicate that the alarm has been activated. If an attempt has been made to break into the car, the LED will glow continuously until the ignition is switched on.

**NOTE:** The alarm is activated when either of the front doors or the trunk/tailgate is locked using a key (or optional remote control locking system), even if a door or the trunk/tailgate is open. The system will not be completely activated however, until all doors and trunk/tailgate are closed.

[pg. 2:6 Front seats](#)

## 1 Height adjustment (manual)

The front section of the driver's seat can be adjusted to seven different height settings and the rear section can be adjusted to nine different height settings.

The front section of the passenger's seat can be adjusted to seven different height settings.

Lever forward = adjustment of front section

Lever rearward = adjustment of rear section

**WARNING!** Do not adjust the seat while driving. The seat should be adjusted so that the brake pedal can be depressed fully. In addition, position the seat as far rearward as comfort and control allow. The seat rails on the floor must not be obstructed in any way when the seat is moved.

## 2 Forward-rearward seat adjustment (manual)

Pull the control upward, then slide the seat forward or rearward to the desired position. Make sure that the seat is properly secured when you release the control.

## Folding front seat

The passenger's seat backrest has a quick forward release mechanism which can be used when long loads are carried. See page 2:22.

### 3 Backrest angle (manual)

Rotate the control counterclockwise to tilt the backrest rearward and clockwise to tilt the backrest forward.

### 4 Lumbar support \*

Firm: turn clockwise

Soft: turn counter-clockwise.

\* Driver's seat only on certain models



Electrically operated seats with memory function (certain models)

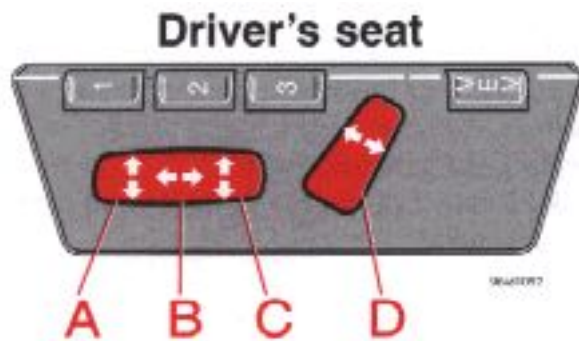

*Power seat control panel*

- A Seat front (raise/lower)
- B Forward - rearward
- C Seat rear (raise/lower)
- D Backrest tilt

**WARNING!** The power seats are operable with the ignition OFF. Therefore, children should never be left unattended in the car.

Movement of the seat can be STOPPED at any time by pressing any button on the power seat control panel.

Refer to the following page for information on programming the memory function.

[pg. 2:7 Electrically operated driver's seat, Rear/side-view mirrors](#)



### Programming the memory

Three seat positions can be programmed. To program a seat position:

- 1 Adjust the seat to the desired position.
- 2 Depress the MEM button.

3 Press button 1 to program the current position of the seat.

Buttons 2 and 3 can be programmed in the same way. To move the seat to a programmed position, depress button 1, 2 or 3 until the seat stops. If the button is released before the seat has reached the programmed position, it will stop as a safety precaution.

**NOTE:** The seat has an overload protector which engages if an object blocks the movement of the seat. If this happens, remove the object and wait 20 seconds before operating the seat again.

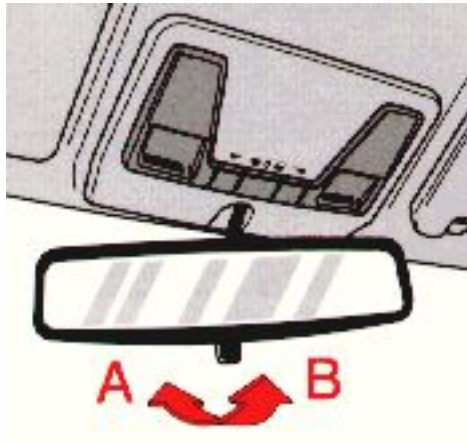

Rear-view mirror

A Normal position

B Night position, reduces glare from following headlights

**CAUTION:** Never use ice scrapers made of metal as they can easily scratch the mirror surface.

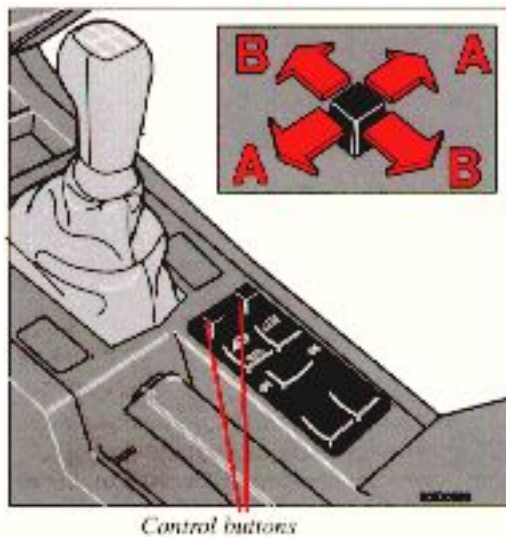

## Electrically operated side-view mirrors

The control switches are located in the center console, beside the parking brake.

A Lateral adjustment

B Vertical adjustment

**WARNING!** The mirrors should always be adjusted prior to driving. Objects seen in the wide-angle right side-view mirror are closer than they appear to be.

[pg. 2:8 Interior lights, Vanity mirror](#)

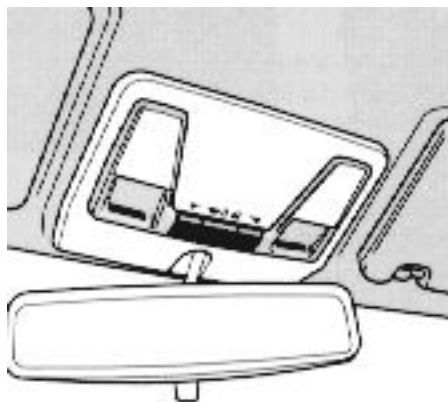



## Front courtesy lights

The front courtesy lighting consists of two reading lights for the front seat occupants.

☛ Front and rear reading lights always on

0 Front and rear reading lights always off

 Front and rear reading lights come on when a door is opened

 Left or right reading light illuminates if the center switch is in position .

The courtesy lights remain illuminated for 30 seconds after the doors have been closed but will be switched off if the ignition is turned on or the doors are locked.

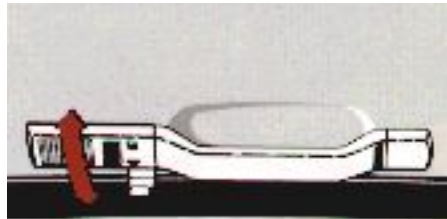

Reading lights, rear seat

There are two reading lights for the rear seat passengers. These are turned on/off by using the adjacent switches.

 Light is on if the front switch is in position .

 Light turns on if any door is opened.

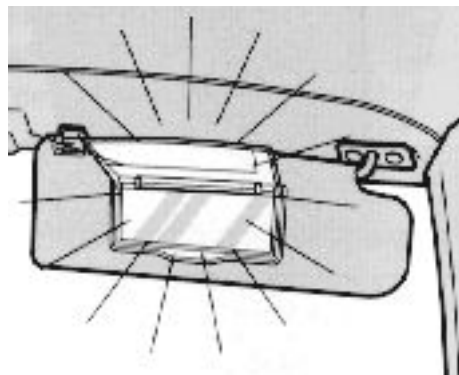

Vanity mirrors

The light illuminates when the cover is opened.





[Contents](#) | [Top of Page](#)

## pg. 2:16 Folding rear seat (sedan)

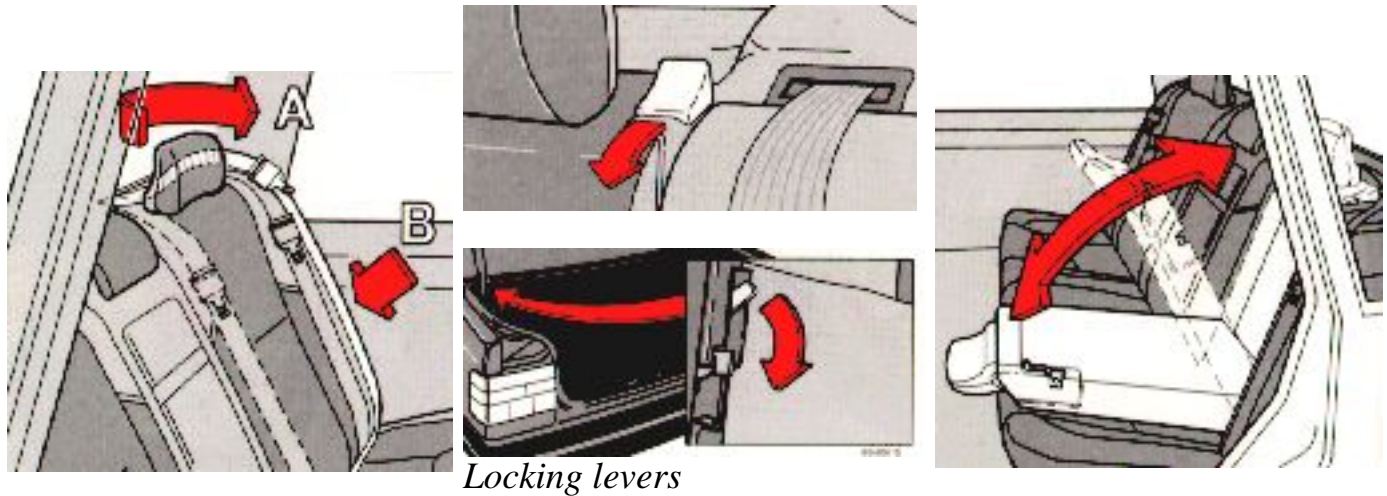

## Folding rear seat

The rear seat is split into two sections so that each section can be folded independently.

- Lift the rear seat belts to the fixed section of the backrest. The center seat belt can also be folded across the fixed part of the backrest so that it does not get in the way if the right-hand backrest is folded down (see illustration above).

- Pull the catch forward and fold the backrest down.

The two red levers on the rear side of the backrests can be used to bypass the folding mechanism and prevent the backrests from being folded down from inside the car. Push the levers down to lock backrests in the upright position. This function can be used to limit access to the trunk.

- When folding the backrests up, make sure the seat belts return to their normal positions.

**WARNING!** When the backrest is returned to the upright position, check that it is properly locked in place.

**NOTE:** If the backrest is folded down for prolonged periods, the seat belt locks could be covered (i.e., with a towel) to help avoid marks on the backrest upholstery.

## pg. 2:17 Folding rear seat (wagon)

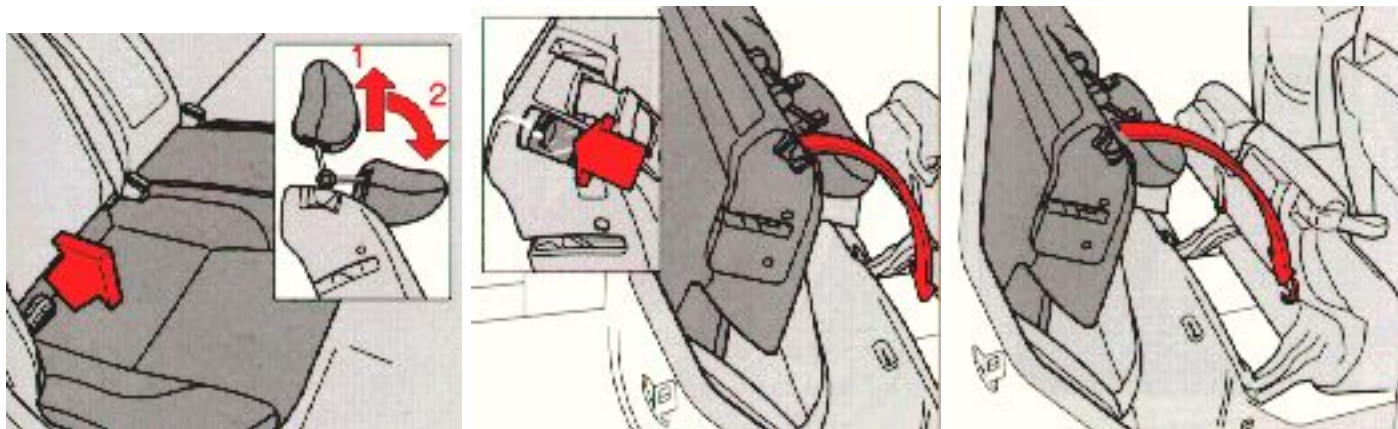

*Seat cushion strap    Release lever - backrest    Hooks fit into holes*

### Folding rear seat (wagon)

The rear seat is split into two sections so that each section can be folded independently.

- Straighten front seat backrests if they are tilted too far to the rear.
- Pull the strap to lift the rear seat cushion and swing the cushion up and toward the back of the front seats.
- The outboard head restraints must be lowered before the backrest is folded down (see inset illustration above):  
1 - pull straight up, 2 - fold forward

- Push the center head restraint straight down if it has been raised.
- Move the backrest release lever rearward and fold the backrest down.
- Check that the hooks under the seat cushions engage the holes on the top edge of the backrest.

When the backrest is raised, the outboard head restraints must be returned to their normal position.

The backrest must lock into place. The red lock indicator will not be visible if the seat has locked into place correctly.

The seat belts must be correctly positioned when the seat is returned to the normal position.

**WARNING!** When the rear seat is folded down, do not place heavy objects against the backs of the front seats. This places a severe strain on the folded down backrest of the rear seat. Cargo must not be stacked higher than the top of seatbacks. This will reduce the possibility of luggage, etc. becoming projectiles during sudden maneuvers, rapid braking or an accident. The red lock indicator is **VISIBLE** when the backrest is **NOT** locked in position and not visible when the backrest is correctly locked in place. When the backrest is in the upright position, it must always be correctly locked in place.

[pg. 2:18 Removing seat cushions, Concealed storage bin \(wagon\)](#)



## Removing seat cushions

The seat cushion can be easily removed to provide a slightly larger cargo storage area.

- Fold the seat cushion toward the back of the front seats
- Release the red catches
- Disconnect the connector for the rear seat heating (certain models)
- Fold the cushion back to a nearly horizontal position.
- Lift out the cushion

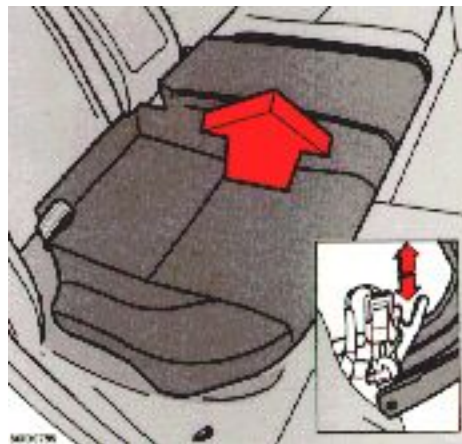

**WARNING!** Do not place extremely heavy articles against the front seats, as the backrest which is folded down is then placed under severe strain.

Be sure to secure cargo. Hard and sharp articles could otherwise damage the frontseat backrest and/or cause injury to passengers in the event of rapid braking or a collision.

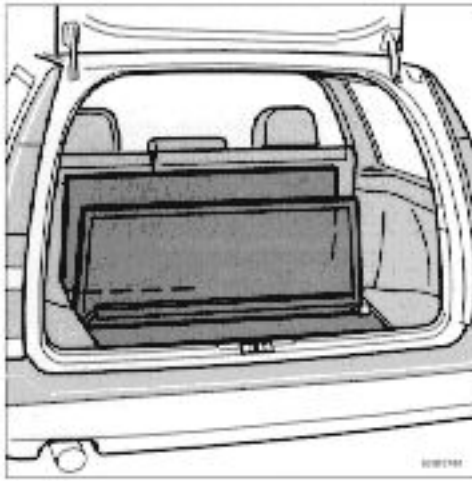

*The lid of the storage compartment is hinged in the middle*

### Concealed storage bin

The storage compartment under the floor of the cargo space is hinged in the middle and can be locked with a key.

[pg. 2:19 luggage cover \(certain models\)](#)

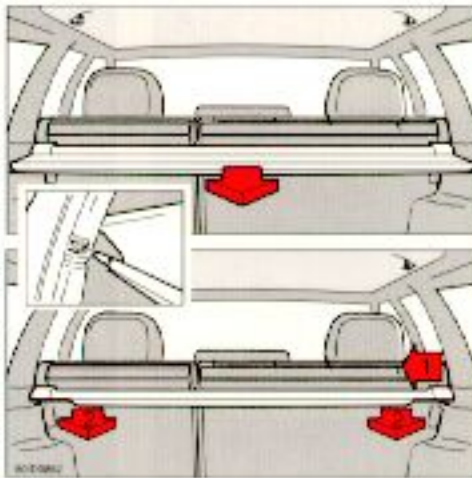

### Luggage cover (wagons)

To open:

Pull the luggage cover toward the rear of the cargo space and attach it to the holes provided.

To remove:

- Retract (roll up) the luggage cover.
- Press the right side of the cover to release it from the brackets.
- Remove the cover from the car.
- Install the cover in the reverse order.

**CAUTION:** Avoid damaging the radio antenna embedded in the side rear window when removing/ installing the luggage cover.

[pg. 2:20 Luggage net - wagons \(certain models\)](#)

## Luggage net

The luggage net unreels from the rear upper edge of the rear seat backrest. The luggage net must be accessed from the cargo storage area.

1 Open the cover on the passenger side seat back and pull the luggage net toward you.



2 Hook the rod onto the bracket on the right side ceiling.

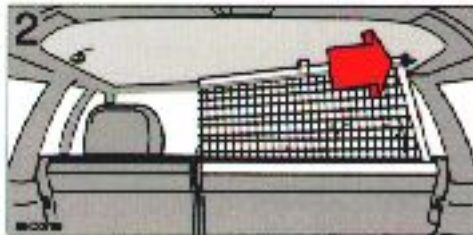

3 Pull out the left side of the rod and attach it to the bracket on the driver's side ceiling.

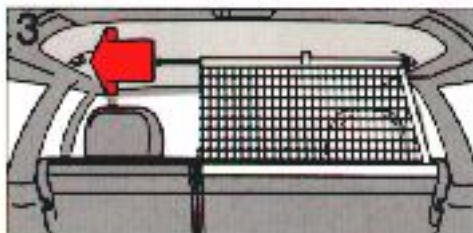

4 Unreel the driver's side luggage net.

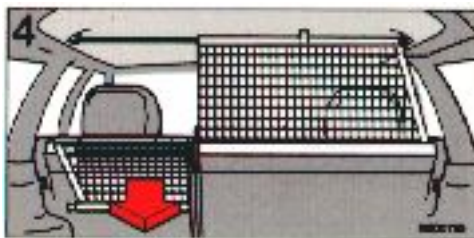

5 Hook it to the rod.

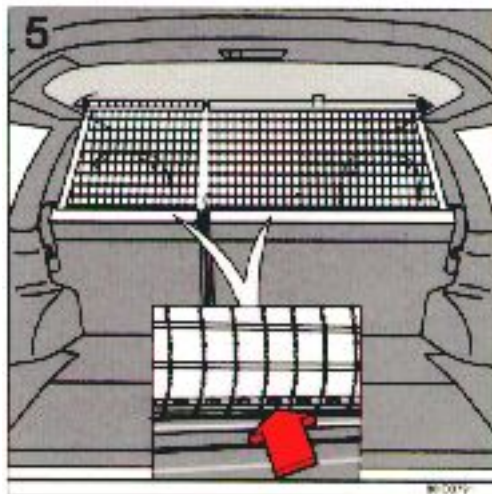

6 Make sure the nets are securely attached to the hooks under the covers and pulled taut. Use the reverse procedure to retract the net.

The luggage net can also be used when the rear seat is folded down. However, extra brackets (optional) must be installed on the upper front door hand grips.

[pg. 2:21 Securing cargo](#)

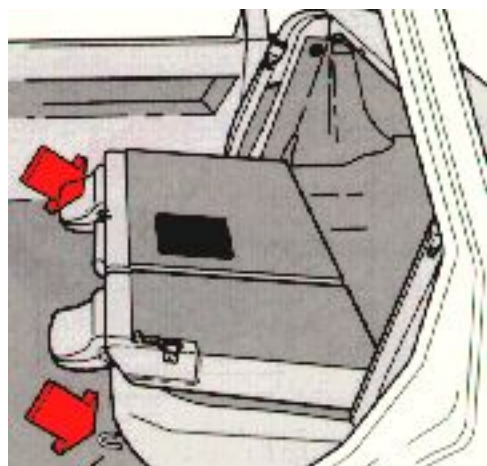
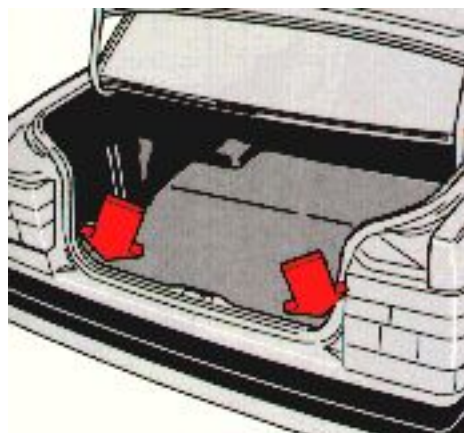

*Eyelets in trunk (sedans) Eyelets inside car (sedans/wagons) Eyelets in cargo area (wagons)*

## Securing cargo

As a safety precaution, your car is equipped with four eyelets (six on wagons) to which straps can be attached to secure luggage.

**WARNING!** The eyelets are not to be used as passenger restraints or as anchorages for child restraints. See page 3:9.

Station wagons only:

Unless the station wagon is equipped with Volvo's auxiliary seat for children (option) passengers should not ride in the rear cargo area.

Station wagons only:

If the optional auxiliary seat for children is in use, fold this seat down before folding down the rear seat backrest.

[pg. 2:22 Folding front seat \(sedans/wagons\), Long load storage \(sedans\)](#)

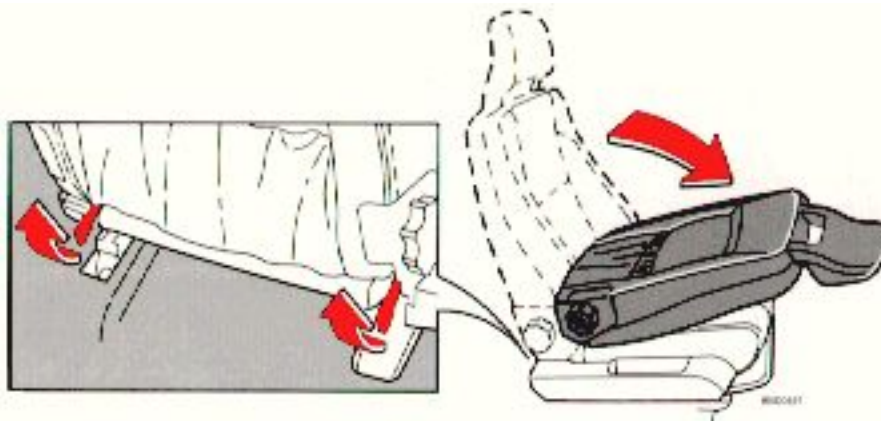

### Folding front seat (certain models)

The passenger seat backrest can be folded down to the horizontal position for carrying long loads. To fold down the backrest:

- Move the seat as far rearward as possible.
- Adjust the backrest tilt to the most upright position



- Lift the catches on the lower rear side of the backrest
- Without releasing the catches, push the backrest forward
- Move the seat as far forward as possible.

**WARNING!** Cover sharp edges on the load to help prevent injury to occupants. Secure the load to help prevent shifting during sudden stops.

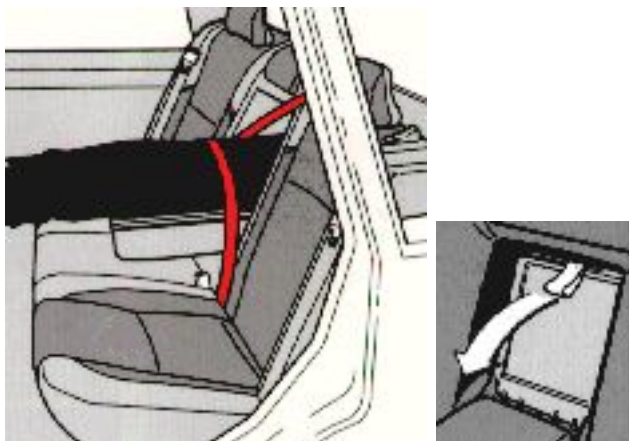

### Long load storage (sedans)

There is a flap located in the panel behind the rear seat which makes it possible to carry long loads such as skis, etc. To open, pull the strap forward.

Protective covers (for skis) should be used to avoid soiling or tearing the upholstery. Please note that the flap in the rear seat is only intended for light loads such as skis, carpets, etc.

Max. length: 6 1/2 ft (2 meters) Max. weight: 55 lbs (25 kg)

**WARNING!** Always turn the engine off and apply parking brake when loading/unloading the vehicle. Place the transmission in the P (PARK) position to help prevent inadvertent movement of the gear selector.



[Contents](#) | [Top of Page](#)

## pg. 2:9 Sun roof (option)

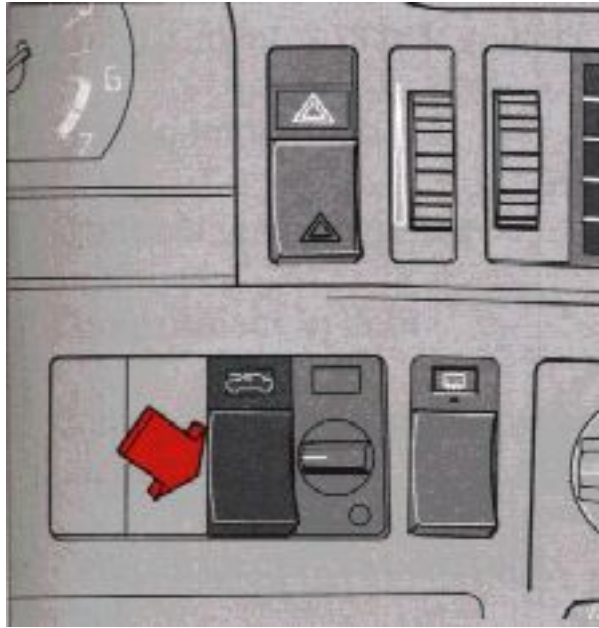

## Electrically-operated sun roof

The switch for operating the sun roof is located on the instrument panel. The starting (ignition) key must first be turned to the drive position. On certain models, the sun roof is equipped with a one-touch, AUTO-open function.

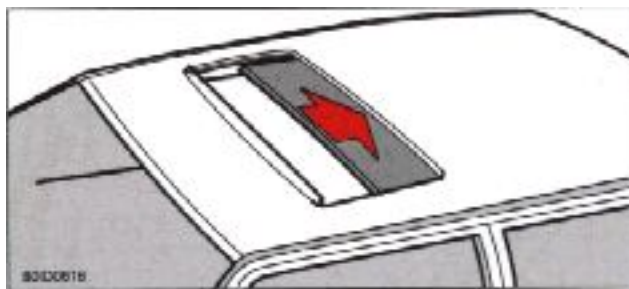

- To slide open the sun roof: Depress the lower section of the switch until the sun roof has opened to the position you prefer or hold the switch until the sun roof reaches the "comfort position"\*. Depress the lower section of the switch again to open the sun roof completely.
- AUTO-open: Press the lower section of the switch once to automatically open the sun roof to the "comfort position"\*. Press again to open the sun roof completely. The AUTO-open function can be stopped at any time by pressing the switch.
- To close the sun-roof : Depress the upper section of the switch *until the sun roof has closed completely* .
- *To open the rear edge of the sun roof (ventilation position) : With the sun roof closed, depress the upper section of the switch. To close, depress the lower section of the switch until the sun roof has closed completely.*

\* A position where the sun roof is not quite fully open. This position helps alleviate "rumbling" wind noise.

Sun visor: The sun roof also features a sliding sun visor. The visor slides back automatically when the sun roof is opened and also slides back slightly when the sun roof is opened to the ventilation position. The visor must be closed manually.

**CAUTION:** Do not close the sun visor when the sun roof is in the ventilation position as this could damage the mechanism.

**NOTE:**

The electrically-operated sun roof has an overload protecting circuit breaker which is activated when an object blocks the sun roof. Should this occur, remove the object and wait 20 seconds for the circuit breaker to reset. The sun roof should then function normally. In case of a sun roof malfunction, see "Service diagnosis", page 6:17.

**WARNING!** The sun roof must never be obstructed in any way when in operation.

[pg. 2:10 Hood](#)

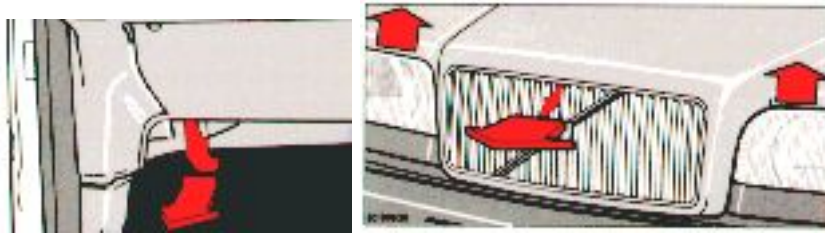

## To open the hood

Pull the lever located under the left side of the dash to release both hood catches. This also releases and exposes the safety handle in the front of the grille.

- Lift the hood slightly to expose the safety handle.
- Pull the safety handle and open the hood.

Do not lift the hood using the safety handle.

**WARNING!** Check that the hood locks properly when closed.

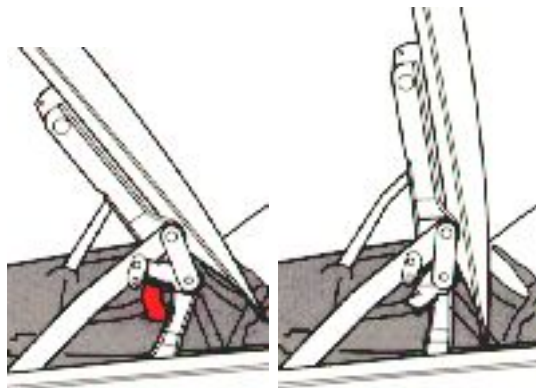

The hood normally opens to an angle of 57°. The hood can be opened to the vertical position by rotating the hinge catches (see illustrations). The catches will return to their normal positions when the hood is closed. Ensure adequate clearance in low-roof garages to avoid damaging the hood.

[pg. 2:11 Storage compartments](#)

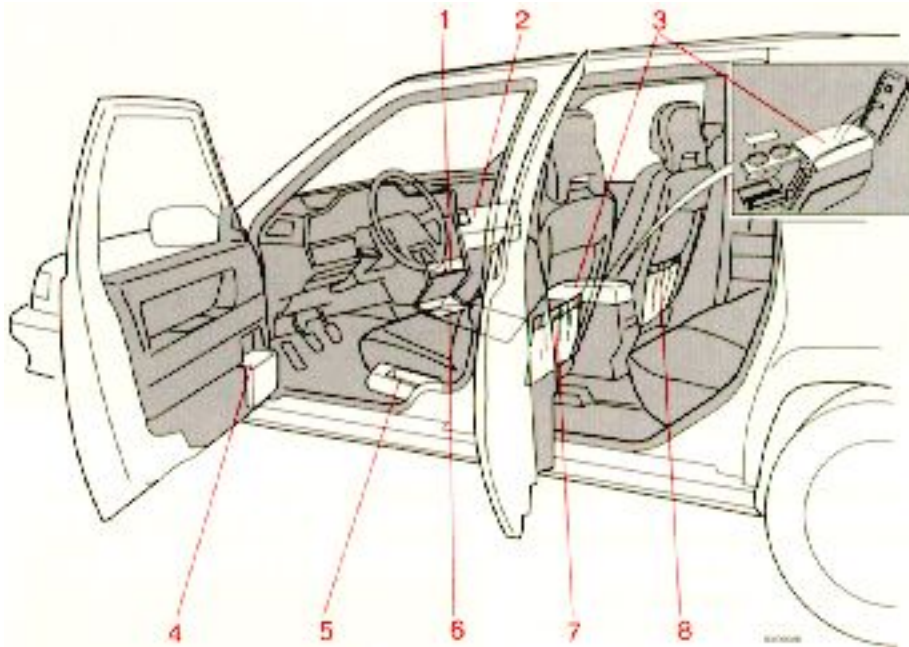

- 1 Compartment in center console
- 2 Glove compartment
- 3 Compartment in armrest/mug holder (certain models)
- 4 Compartment in door
- 5 Compartment beside front seat (certain models)
- 6 Compartment between front seats
- 7 Pocket on rear of front seat
- 8 Pocket on rear of front seat

**WARNING!** Packages on the rear window shelf can obscure vision and may become dangerous projectiles in the event of a sudden stop or an accident.

[pg. 2:12 Child safety locks, Trunk lid \(sedan\)](#)

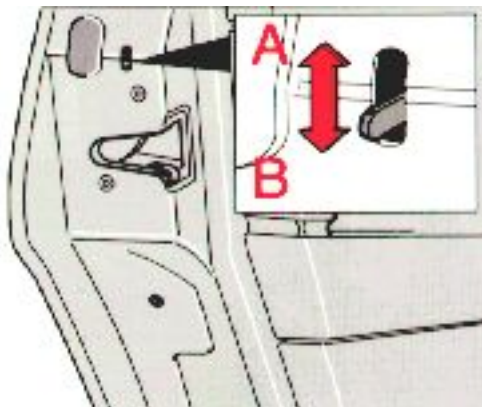

## Child safety locks

The controls are located on the rear door jams.

A The door cannot be opened from the inside. Normal operation from outside.

B The door lock functions normally.

**WARNING!** Remember, in the event of an accident, the rear seat passengers cannot open the doors from the inside with the buttons in position A.

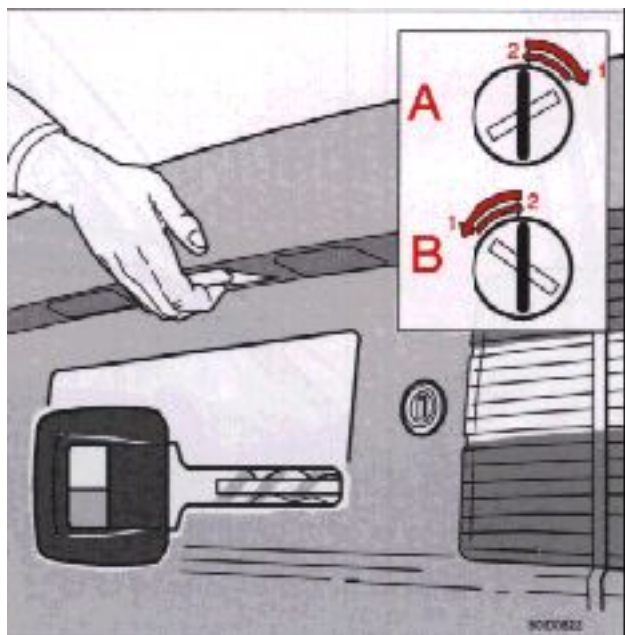

## Trunk lid

The trunk lock is incorporated in the central locking system. This means that you can either lock or unlock the trunk by means of either of the front doors.

You can also operate the trunk lock directly with the master key even if the vehicle is centrally locked. Locking or unlocking the trunk lid will also unlock the doors.

The trunk can also be disconnected from the central locking system by turning the key counterclockwise as shown below:



Withdraw the key in the horizontal position.

The trunk is now always locked. The optional folding rear seatback can also be locked from the trunk (see page 2:16). This feature can be used for example, if you lend your car to someone. If you give only the service key to the driver, it will not be possible to gain

## Occupant safety, Reporting safety defects

pg. 3:1 Occupant safety

### Occupant safety

Despite our strongest recommendations, and your best intentions, not wearing a seat belt is like believing "It'll never happen to me!". Volvo urges you and all adult occupants of your car to wear seat belts and ensure that children are properly restrained, using an infant, car or booster seat determined by age, weight and height.

Fact: In every state and province, some type of child-restraint legislation has been passed. Additionally, most states and provinces have already made it mandatory for occupants of a car to use seat belts. So, urging you to "buckle up" is not just our recommendation - legislation in your state or province may mandate seat belt usage. The few seconds it takes to buckle up may one day allow you to say, "It's a good thing I was wearing my seat belt".



[3:2](#) Seat belts

[3:4](#) Volvo SRS

[3:8](#) Side Impact Protection System - (SIPS) air bag

[3:9](#) Child safety

[3:12](#) Occupant safety

[3:12](#) Reporting Safety Defects

pg. 3:2 Seat belts

### Seat belts

Always fasten the seat belts before you drive or ride.

Two lights above the rear view mirror will be illuminated for 4-8 seconds after the starting (ignition) key



is turned to the driving position. A chime will sound at the same time if the driver has not fastened his seat belt. The rear seats are provided with self-retracting inertia reel belts. The front seats are provided with single roller belts with tensioners.

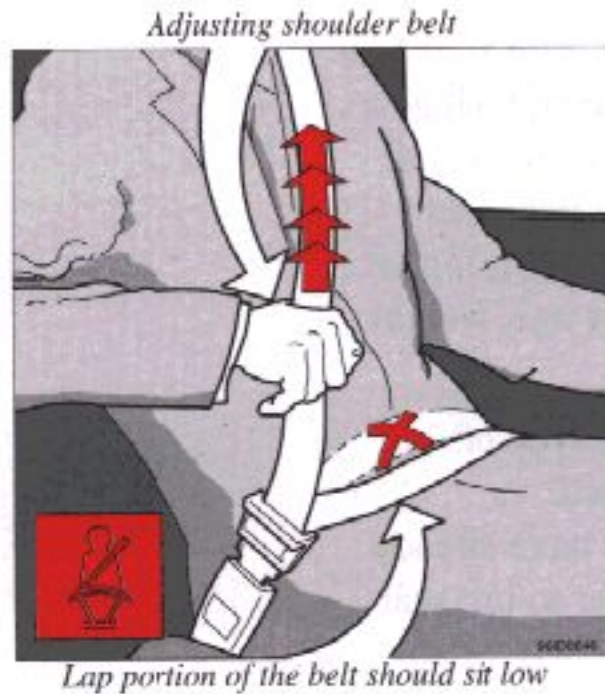

#### To buckle:

Pull the belt out far enough to insert the latch plate into the receptacle (buckle for rear seats) until a distinct snapping sound is heard. The seat belt retractor is normally "unlocked" and you can move freely, provided that the shoulder belt is not pulled out too far. The retractor will lock up as follows:

- if the belt is pulled out rapidly
- during braking and acceleration
- if the vehicle is leaning excessively
- when driving in turns

For the seat belt to provide maximum protection in the event of an accident, it must be worn correctly.

When wearing the seat belt remember:

- The belt should not be twisted or turned.
- The lap belt must be positioned low on the hips (not pressing against the abdomen).
- The shoulder section of the front seat belts adjusts automatically to the driver's height.

Make sure that the shoulder belt is rolled up into its retractor and that the shoulder and lap belts are taut.

Before exiting the car, check that the seat belt retracts fully after being unbuckled.

If necessary, guide the belt back into the retractor slot.

**NOTE:** Legislation in your state or province may mandate seat belt usage.

**WARNING!** Any device used to induce slack into the shoulder belt portion of the three-point belt system will have a detrimental effect on the amount of protection available to you in the event of a collision. The seat back should not be tilted too far back. The shoulder belt must be taut in order to function properly.

[pg. 3:3 Seat belts, Center head restraint](#)



During pregnancy

Pregnant women should always wear seat belts. Remember that the belt should always be positioned in such a way as to avoid any possible pressure on the abdomen. The lap portion of the belt should be located low, as shown in the above illustration.

**WARNING!** Never use a seat belt for more than one occupant. Never wear the shoulder portion of the belt under the arm, behind the back or otherwise out of position. Such use could cause injury in event of accident. As the seat belts lose much of their strength when exposed to violent stretching, they should be replaced after any collision, even if they may appear to be undamaged. Never repair the belt on your own; have this done by an authorized Volvo dealer only.

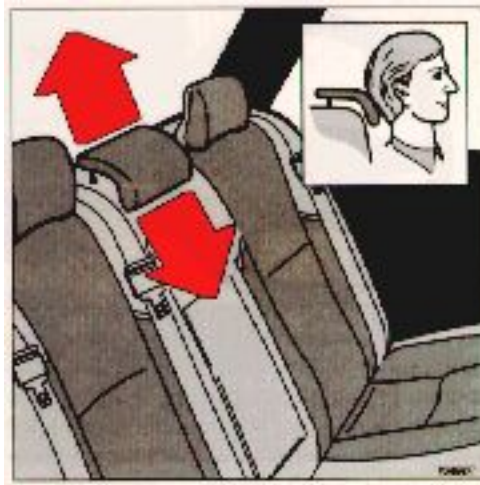

### Center head restraint

The center head restraint can be adjusted according to the passenger's height. The restraint should be carefully adjusted to support the occupant's head.

To raise: Pull straight up

To lower: Pull forward and push down

[pg. 3:4 Volvo SRS](#)



As an enhancement to the three-point seat belt system, your Volvo is equipped with a Supplemental Restraint System (SRS). The Volvo SRS consists of an airbag (2) and knee bolster (5) on both the driver's and passenger's sides and seat belt tensioners in both front door pillars (4). The system is designed to supplement the protection provided by the three-point seat belt system.

The SRS system is indicated by the "SRS" embossed on the steering wheel pad and above the glove compartment, the knee bolsters beneath the steering column and the glove compartment and decals on

both sun visors and on the far right side of the dash.

The airbags are folded and located in the center of the steering wheel and above the glove compartment. They are released only during certain frontal or front-angular collisions, depending on the crash severity, angle, speed and object impacted. Both airbags and seat belt tensioners will deploy, even if the passenger seat is not occupied.

### WARNING!

As its name implies, SRS is designed to be a SUPPLEMENT to - not a replacement for - the three-point belt system. The airbag is designed not to be released in the event of a side or rear-end collision, or during a roll-over situation. For maximum protection, wear seat belts at all times. Be aware that no system can prevent all possible injuries that may occur in an accident.



The airbag system includes gas generators (1) surrounded by the airbags (2) and front seat belt tensioners for both of the front seats (4). To deploy the system, the sensor (3) activates the gas generators causing the airbags to be inflated with nitrogen gas. As the movement of the seat's occupants compresses the airbags, some of the gas is expelled at a controlled rate to provide better cushioning. Both seat belt tensioners also deploy, minimizing any seat belt slack.

The entire process, including inflation and deflation of the airbags, takes approximately two-tenths of a second.

**WARNING!**

When installing any optional equipment, make sure that the SRS system is not damaged. Do not attempt to service any component of the SRS yourself. Attempting to do so may result in serious personal injury. If a problem arises, take your car to the nearest authorized Volvo dealer for inspection as soon as possible.

[pg. 3:5 Volvo SRS \(cont.\)](#)

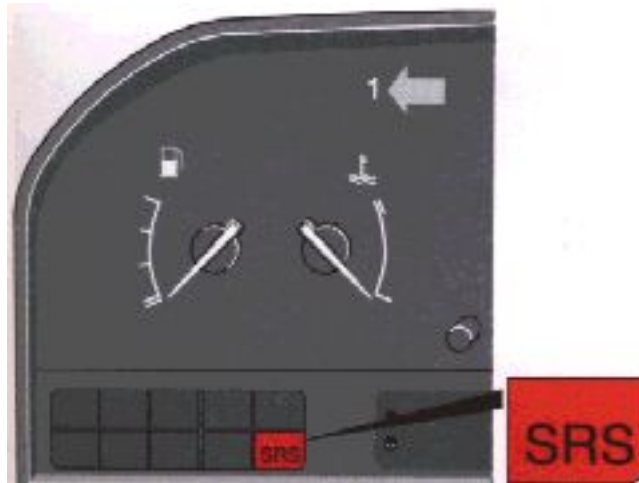

A self-diagnostic system incorporated in the sensor monitors the SRS (does not monitor the SIPS airbags). If a fault is detected, the "SRS" warning light will illuminate. The light is included in the warning/indicator light cluster in the instrument panel. Normally, the SRS warning lamp should light up when the ignition is switched on and should go out after 10 seconds or when the engine is started. Check that this light is functioning properly every time the car is started.

The following items are monitored by the self-diagnostic system:

- Sensor unit
- Cable harness
- Gas generator ignitors

**WARNING!**

Never drive an SRS equipped car with your hands on the steering wheel pad / airbag housing. No objects, accessory equipment or stickers may be placed on, attached to or installed near the SRS cover in the center of the steering wheel or the area affected by the airbag deployment. If the SRS warning light stays on after the engine has started or if it comes on while you are driving, drive the car to the nearest authorized Volvo dealer for inspection as soon as possible.



*The above is a sample of the label found on all seat belts equipped with tensioners, located on the front seat belts near the lower anchorage point.*



*The above is a sample of the decal which can be found on the driver's door pillar.*

There is no maintenance to perform on the SRS yourself. The only periodic maintenance recommended on the SRS is that the air bag modules and front seat belts (including tensioners) should be replaced approximately every ten years and that the other components in the system (wiring, connectors, etc.) should also be inspected at this time. The SRS decal on your car shows the month and year servicing is due. This service must be performed by an authorized Volvo dealer.

pg. 3:6 Volvo SRS (cont.)



*SRS text at far right of instrument panel*



*SRS texts on inside of both sun visors*



*SRS texts on outside of both sun visors*



*Passenger side air bag*

**WARNING!** Do not use child safety seats or child boosters cushions/backrests in the front passenger's seat. We also recommend that children who have outgrown these devices sit in the rear seat with the seat belt properly fastened.

**WARNING!**

- Occupants in the front passenger's seat must never sit on the edge of the seat, sit leaning toward the instrument panel or otherwise sit out of position. The occupant's back must be as upright as comfort allows and be against the seat back with the seat belt properly fastened.
- Feet must be on the floor, e.g. not on the dash, seat or out of the window.
- Children must never be allowed to stand in front of the passenger seat.
- No objects or accessory equipment, e.g. dash covers, may be placed on, attached to or installed near the SRS hatch (the area above the glove compartment) or the area affected by airbag deployment (see illustration).
- There should be no loose articles, e.g. coffee cups, on the floor, seat or dash area.
- Never try to open the SRS cover on the steering wheel or the passenger side SRS hatch. This should only be done by an authorized Volvo service technician.

NOTE: Deployment of SRS components occurs only one time during an accident. In a collision where deployment occurs, the air bags and seat belt tensioners activate. Some noise occurs and a small amount of powder is released. This powder is not harmful and does not indicate fire.

[pg. 3:7 Volvo SRS \(cont.\)](#)

NOTE: The information on this page does not pertain to the Side Impact Protection System airbags.

When are the airbags deployed?

The SRS system is designed to deploy only during certain frontal or front-angular collisions, depending in the crash severity, angle, speed, and object impacted. The SRS sensor is designed to react to both the impact of the collision and the inertial forces generated by it and to determine if the intensity of the collision is sufficient for the airbags to be deployed.

NOTE: The SRS system activates only once in a collision.

If the airbags have been deployed, we recommend the following:

Have the car towed to an authorized Volvo dealer. Even if it can be driven after an accident, we do not recommend driving the car with deployed airbags.

Have an authorized Volvo dealer replace the SRS system components.



Use only new, Genuine Volvo Parts when replacing SRS components (airbags, seat belts, tensioners, etc.)

When are the airbags NOT deployed?

Not all frontal collisions activate the SRS system. If the collision involves a non-rigid object (e.g., a snow drift or bush), or a rigid, fixed object at a low speed, the SRS system will not necessarily deploy. The airbags in the steering wheel and above the glove compartment do not normally deploy in a side impact collision, in a collision from the rear or in a rollover situation. The amount of damage to the bodywork does not reliably indicate if the airbags should have deployed or not.

Can the airbags deploy accidentally?

The entire SRS system is constructed so that the airbags only inflate in certain collision situations. The SRS system has its own diagnostic unit which continuously monitors and inspects the system. Make a habit of checking the SRS warning light when starting and driving the car. Normally, this light will come on when the ignition is switched on and should go out after approximately 10 seconds or when the engine is started. If this light should stay on or come on while you are driving, drive the car to an authorized Volvo dealer for inspection as soon as possible.

Seat belts - the heart of the Volvo safety system

The heart of the Volvo safety system is the three-point seat belt! In order for the SRS system to provide the protection intended, seat belts must be worn at all times by everyone in the car.

The SRS system is a supplement to the seat belts.

**WARNING!** If your car has been subjected to flood conditions (e.g. soaked carpeting/standing water on the floor of the vehicle) or if your car has become flood-damaged in any way, **DO NOT ATTEMPT TO START THE CAR.** This may cause airbag deployment which could result in personal injury. Have the car towed to an authorized Volvo dealer for repairs.

Automatic transmission only:

Before attempting to tow the car, use the following procedure to override the shiftlock system to move the gear selector to the neutral position.

- Disconnect the battery.
- Wait at least one minute.
- Insert the key in the ignition and turn it to position I.
- Press firmly on the shiftlock override button (located near the base of the gear selector).
- While holding the override button down, move the gear selector from the park position.



[Contents](#) | [Top of Page](#)

## pg. 3:8 Side Impact Protection System (SIPS) airbag (certain models)

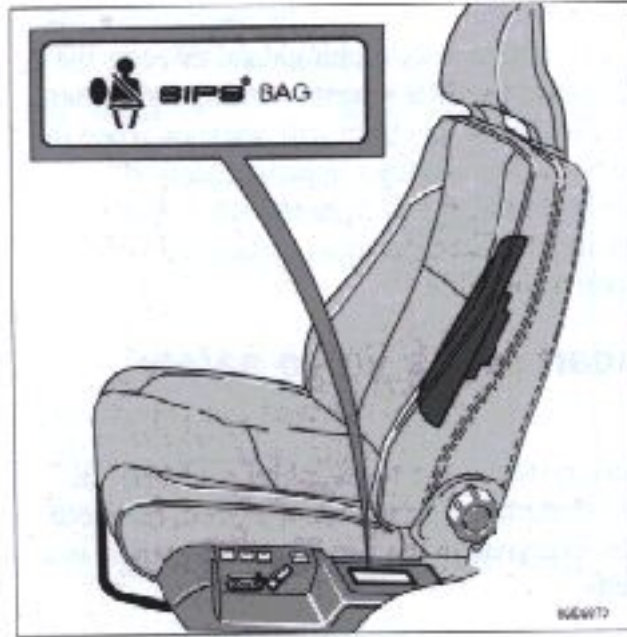

*SIPS airbag decal \**

### SIPS airbag (front seats only)

As an enhancement to the structural Side Impact Protection System built into your car, certain models are also equipped with Side Impact Protection System (SIPS) airbags. The SIPS airbag system consists of airbag modules built into the sides of both front seat backrests (1), leads (2) from these modules to the mechanical sensor units (3) and gas generators (4).

The SIPS airbag system is designed to help increase occupant protection in the event of certain side impact collisions. The SIPS airbags are designed to deploy only during certain side-impact collisions, depending on the crash severity, angle, speed, and point of impact. The airbags are not designed to deploy in all side impact situations.

## WARNING!

- The SIPS airbag system is a supplement to the Side Impact Protection System and the three-point seat belt system. It is not designed to deploy during collisions from the front or rear of the car or in rollover situations.
- Only Volvo approved seat covers may be used. The use of non-approved aftermarket seat covers may impede SIPS airbag deployment.
- No objects, accessory equipment or stickers may be placed on, attached to or installed near the SIPS airbag system or in the area affected by SIPS airbag deployment (see illustration to the right above).
- Never try to open or repair any components of the SIPS airbag system. This should only be done by an authorized Volvo service technician.
- For best protection from the SIPS airbag system, both front seat occupants should sit in an upright position with the seat belt properly fastened.

NOTE: SIPS airbag deployment (one airbag) occurs only on the side of the vehicle affected by the impact.



*1 - Airbag, 2 - lead, 3 - sensor unit, 4 - gas generator*

\* A SIPS airbag warning decal is located at the end of the instrument panel on the driver's side of the car.

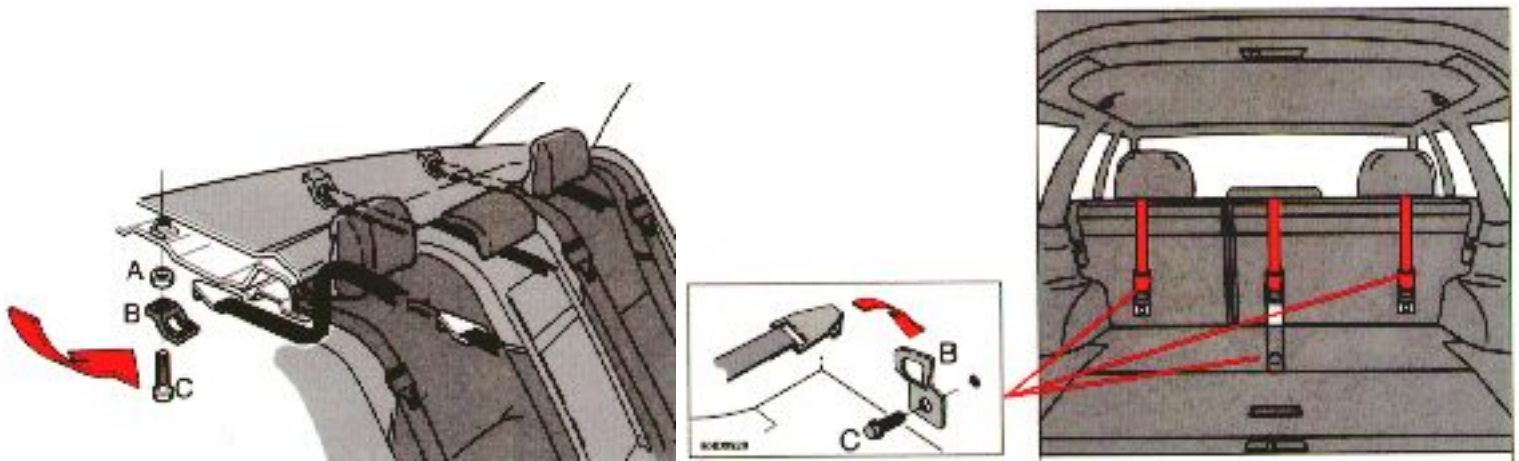

*Sedan A - 10mm spacer, B - anchorage plate Wagon  
C - 5/16" UNC bolt*

## Child Restraint Anchorages

Volvo cars are fitted with Child Restraint Top Tether Anchorages in the rear seat.

Sedans: There are three pre-drilled anchorage points under the rear window shelf which are not visible from the passenger compartment.

Wagons: The anchorage points are on the rear seat backrest and are hidden by plastic covers. The backrest must be folded down to access the center anchorage point.

In cars designed for Canada, one top tether anchorage set will be in the glove box.

## Installing the top tether

Sedans: The pre-drilled holes for the child restraint anchorages are underneath the rear window shelf and can be accessed from the trunk or by lowering the rear seat backrests.

Wagons: Remove the plastic cover from the anchorage point you intend to use.

On either model, refer to the child seat manufacturer's instructions for securing the seat.

An additional bolt may be required. This can be obtained from your authorized Volvo dealer.

**WARNING!** Child Restraint Anchorages are designed to withstand only those loads imposed by correctly fitted Child Restraints. Under no circumstances are they to be used for adult seat belts or harnesses. The anchorages are not able to withstand excessive forces on them in the event of collision if full harness seat belts or adult seat belts are installed to them. An adult who uses a belt anchored in a Child Restraint Anchorage runs a great risk of suffering severe injuries should a collision occur. Do not install rear speakers which would require the removal of the top tether anchors or interfere with the proper use of the top tether strap.

[pg. 3:10 Child safety \(cont.\)](#)

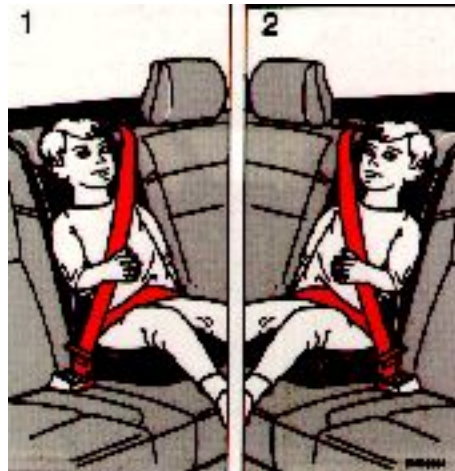

*Integrated booster cushion: 1 - sedan, 2 - wagon*

### Integrated booster cushion (certain models)

Volvo's own integrated booster cushion has been specially designed to help safeguard a child seated in the center position of the rear seat. When using the integrated booster cushion, the child must be secured with the vehicle's three-point seat belt. The booster cushion is approved for children weighing between 22.7 and 36 kg (50 and 80 lbs) and between 117 and 137 cm (46 and 54 in ) in height. It is not intended for children under 3 years of age.

With the child properly seated on the booster cushion (see illustration), adjust the head restraint to support the child's head (see page 3:3). The hip section of the three-point seat belt must fit snugly across the child's hips, not across the stomach. The shoulder section of the three-point seat belt should be positioned across the chest and shoulder (see illustration). The shoulder belt must never be placed behind the child's back or under the arm.

**WARNING!** Failure to follow the instructions on this page will increase the risk of your child being injured during a sudden stop or collision. In the event of a collision while the integrated booster cushion was occupied, the entire booster cushion and center seat belt must be replaced. The booster cushion should also be replaced if it is badly worn or damaged in any way. This work should be performed by an authorized Volvo dealer only. The booster cushion should be cleaned while in place in the vehicle if possible. If not, please consult your Volvo dealer.

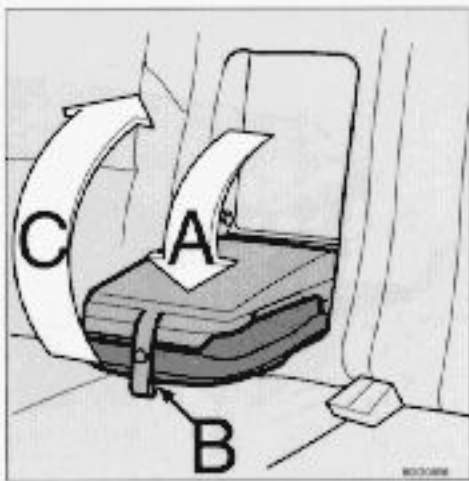

## Storing the booster cushion

To store (fold up):

- Fold down the booster cushion backrest to the seat section (A)
- Snap the backrest strap to the fastener on the seat (B)
- Fold up the booster cushion unit (C)

**NOTE:** The booster cushion must be folded down as one unit. If the backrest is not strapped to the seat section of the cushion, the backrest hinges may lock.

[pg. 3:11 Child safety \(cont.\)](#)

## Child safety

Volvo recommends the proper use of restraint systems for all occupants including children. Remember that, regardless of age and size, a child should always be properly restrained in a car.

Restraint systems for children are designed to be secured in the vehicle by lap belts or the lap portion of a lap-shoulder belt. Such child restraint systems can help protect children in cars in the event of an accident only if they are used properly. However, children could be endangered in a crash if the child restraints are not properly secured in the vehicle. Failure to follow the installation instructions for your child restraint can result in your child striking the vehicle's interior in a sudden stop.

Holding a child in your arms is NOT a suitable substitute for a child restraint system. In an accident, a child held in a person's arms can be crushed between the vehicle's interior and an unrestrained person. The child could also be injured by striking the interior, or by being ejected from the vehicle during a sudden maneuver or impact. The same can also happen if the infant or child rides unrestrained on the seat. Other occupants should also be properly restrained to help reduce the chance of injuries or increasing the injury of a child.

All states and provinces have legislation governing how and where children should be carried in a car. Find out the regulations existing in your state or province. Recent accident statistics have shown that children are safer in rear seating positions than front seating positions when properly restrained. A child restraint system can help protect a child in a vehicle. Here's what to look for when selecting a child restraint system:

- It should have a label certifying that it meets applicable Federal Motor Vehicle Safety Standards (FMVSS 213-80) - or in Canada, CMVSS 213.
- Make sure the child restraint system is approved for the child's height, weight and development - the label required by the standard or regulation, or instructions for infant restraints, typically provide this information.
- In using any child restraint system, we urge you to look carefully over the instructions that are provided with the restraint. Be sure you understand them and can use the device properly and safely in this vehicle. A misused child restraint system can result in increased injuries for both the infant or child and other occupants in the vehicle.
- If your child restraint requires a top tether strap, consult your authorized Volvo dealer for top tether anchorage and installation information.

When a child has outgrown the child safety seat, you should use the rear seat with the standard seat belt fastened. The best way to help protect the child here is to place the child on a cushion so that the seat belt is properly located on the hips (see previous page).

A specially designed and tested booster cushion for children between 22.7 - 36 kg (50 - 80 lbs) and 117 - 137 cm (46 - 54") can be obtained from your Volvo dealer.

If necessary, an auxiliary seat for children is available for use in the luggage compartment of station wagon models. This seat is designed for two children, each weighing between 23 - 40 kg (50 - 88 lbs.) and up to 150 cm (59 inches) in height.



## WARNING!

- When using the auxiliary seat for children, both sections of the rear seat backrest must be secured in the upright position
- Do not use a booster cushion or child seat in conjunction with the auxiliary seat.

[pg. 3:12 Occupant safety](#)

## Seat belt maintenance

Check periodically that the anchor bolts are secure and that the belts are in good condition. Use water and a mild detergent for cleaning. Check seat belt mechanism function as follows: Attach the seat belt and pull rapidly on the strap.

**WARNING!** Check other traffic before performing the following check.

Brake firmly from approximately 30 mph (50 km/h) or turn in a tight circle while pulling on the belt. In the above checks you should not be able to pull the belt out.

## Volvo Concern for Safety

Safety is the cornerstone for Volvo. Our concern dates back to 1927 when the first Volvo rolled off the production line. Three-point seat belts, safety cages, and energy-absorbing impact zones were designed into Volvo cars long before it was fashionable or required by government regulation. We will not compromise our commitment to safety. We continue to seek out new safety features and to refine those already in our cars. You can help. We would appreciate hearing your suggestions about improving automobile safety. We also want to know if you ever have a safety concern with your car. Call us in the U.S. at: 800-458-1552 or in Canada at: 800-663-8255.

## Occupant safety

How safely you drive doesn't depend on how old you are but rather on:

- how well you see
- your ability to concentrate
- how quickly you make decisions under stress to avoid an accident.

The tips listed below are suggestions to help you cope with the ever changing traffic environment.

- Never drink and drive.
- If you are taking any medication, consult your physician about its potential effects on your driving abilities.
- Take a driver-retaining course
- Have your eyes checked regularly
- Keep your windshield and headlamps clean.
- Replace wiper blades when they start to leave streaks.
- Take into account the traffic, road, and water conditions, particularly with regard to stopping distance.

### Reporting Safety Defects in the U.S.

If you believe that your vehicle has a defect which could cause a crash or could cause injury or death, you should immediately inform the National Highway Traffic Safety Administration (NHTSA) in addition to notifying Volvo Cars of North America. If NHTSA receives similar complaints, it may open an investigation, and if it finds that a safety defect exists in a group of vehicles, it may order a recall and remedy campaign. However, NHTSA cannot become involved in individual problems between you, your dealer, or Volvo Cars of North America. To contact NHTSA, you may either call the Auto Safety Hotline toll-free at 1-800-424-9393 (or 366-0123 in Washington, D.C. area) or write to: NHSTA, U.S. Department of Transportation, Washington D.C. 20590. You can also obtain other information about motor vehicle safety from the Hotline.



[Contents](#) | [Top of Page](#)

## Starting and driving

pg. 4:1 Starting and driving

### Starting and driving

This section on starting and driving contains items such as starting the engine, operating the gear selector, towing, trailers, etc.

- [4:2](#) Break-in period
- [4:2](#) Fuel requirements, Octane rating
- [4:4](#) Driving economy
- [4:5](#) Starting the engine
- [4:6](#) Manual transmission
- [4:7](#) Automatic transmission
- [4:10](#) Points to remember
- [4:12](#) Emergency towing
- [4:13](#) Vehicle towing information
- [4:14](#) Starting with an auxiliary battery (jump starting)
- [4:15](#) Three-way catalytic converter
- [4:16](#) Brake system, ABS
- [4:17](#) Trailer towing
- [4:18](#) Winter driving
- [4:19](#) Long distance trips

pg. 4:2 Break-in period, Fuel requirements

A new car should be broken-in

Refrain from utilizing your car's full driving potential during the first 1,200 miles (2,000 km) including

the "kick-down" function (automatic transmission).

#### NOTE - ENGINE OIL:

Although some oil consumption occurs during normal engine operation, more oil is consumed when the engine is new as the internal parts generate higher friction while wearing-in to each other. From the time the engine is new until the first service is performed, the oil consumption could be higher than normal. For this reason, it is especially important to check the oil every time you refuel your car during this period. See page 8:10.

In general, the rate of oil consumption depends on such factors as: engine temperature, length of trip, driving conditions, oil viscosity and quality, engine speed and acceleration/deceleration.

Checking your engine oil level each time the car is refueled is one of the most important items you can perform to help keep your car in good running order.

#### Manual transmission

The following speeds should not be exceeded during the break-in period:

	Up to 600 miles (1000 km)	600 - 1,200 miles (1000 - 2000 km)
1st gear	20 mph (30 km/h)	25 mph (40 km/h)
2nd gear	30 mph (50 km/h)	40 mph (70 km/h)
3rd gear	45 mph (80 km/h)	65 mph (100 km/h)
4th gear	70 mph (110 km/h)	80 mph (130 km/h)
5th gear/ overdrive	80 mph (130 km/h)	95 mph (150 km/h)

Posted speed limits should not be exceeded.

#### Deposit control gasoline

Volvo recommends the use of gasoline containing deposit control additives. These additives have shown to be efficient in keeping injectors and intake valves clean. Consistent use of deposit control gasolines will help ensure good driveability and fuel economy. If you are not sure whether the gasoline contains deposit control additives, check with the service station operator.

## pg. 4:3 Fuel requirements, Refueling

### Unleaded Fuel

Each Volvo has a three-way catalytic converter and must use only unleaded gasoline (as specified on the instrument panel and by a label near the filler inlet). U.S. and Canadian regulations require that pumps delivering unleaded gasoline be labeled "UNLEADED". Only these pumps have nozzles which fit your car's filler inlet. It is unlawful to dispense leaded fuel into a vehicle labeled "unleaded gasoline only". Leaded gasoline damages the three-way catalytic converter and the heated oxygen sensor system. Repeated use of leaded gasoline will lessen the effectiveness of the emission control system and could result in loss of emission warranty coverage. State and local vehicle inspection programs will make detection of misfueling easier, possibly resulting in emission test failure for misfueled vehicles.

### Octane Rating

Volvo engines are designed for optimum performance on unleaded premium gasoline with an octane rating. AKI of 91, or above. AKI (ANTI KNOCK INDEX) is an average of the Research Octane Number, RON, and the Motor Octane Number, MON,  $(RON + MON / 2)$ . The minimum octane requirement is AKI 87 (RON 91).

### Gasoline containing alcohol and ethers

#### "Oxygenated fuels"

Some fuel suppliers sell gasoline containing "oxygenates" which are usually alcohols or ethers. In some areas, state or local laws require that the service pump be marked indicating use of alcohol or ethers. However, there are areas in which the pumps are unmarked. If you are not sure whether there is alcohol or ethers in the gasoline you buy, check with the service station operator.

To meet seasonal air quality restrictions, some states require the use of "oxygenated" fuel in certain areas.

Volvo allows the use of the following "oxygenated fuels; however, the octane ratings listed on this page must still be met.

#### Alcohol — Ethanol

Fuels containing up to 10% ethanol by volume may be used.

Ethanol may also be referred to as Ethyl alcohol, or "Gasohol".

#### Ethers — MTBE

Fuels containing up to 15% MTBE may be used.

## Refueling

The fuel tank filler cap is located behind the door on the rear fender. Open cap slowly during hot weather conditions.

When filling, hang the cap in the special bracket on the door. After filling the tank, install the cap and turn until a "click" is heard.

The fuel tank is designed to hold approximately 19.3 US gal. (73 liters) with sufficient volume left over to accommodate possible expansion of the fuel in hot weather. Be aware that the "usable" tank will be somewhat less than the specified maximum. When the fuel level is low, such factors as ambient temperature, the fuel's "vapor pressure" characteristics, and terrain can affect the fuel pumps' ability to supply the engine with an adequate supply of fuel. Therefore, it is advisable to refuel as soon as possible when the needle nears the red zone, or when the fuel warning light comes on.

**CAUTION:** Take care not to spill gasoline during refueling. Gasolines containing alcohol can cause damage to painted surfaces, which may not be covered under the New Vehicle Limited Warranty. Do not use gasoline containing methanol (methyl alcohol, wood alcohol). This practice can result in vehicle performance deterioration and can damage critical parts in the fuel system. Such damage may not be covered under the New Vehicle Limited Warranty.

[pg. 4:4 Driving economy](#)

Economical driving does not necessarily mean driving slowly

Better driving economy may be obtained by thinking ahead, avoiding rapid starts and stops and adjusting the speed of your vehicle to immediate traffic conditions. Observe the following rules:

- Bring the engine to normal operating temperature as soon as possible by driving with a light foot on the accelerator pedal for the first few minutes of operation. A cold engine uses more fuel and is subject to increased wear.
- Whenever possible, avoid using the car for driving short distances. This does not allow the engine to reach normal operating temperature.
- Drive carefully and avoid rapid acceleration and hard braking.
- Do not exceed speed limit.
- Avoid carrying unnecessary items (extra load) in the

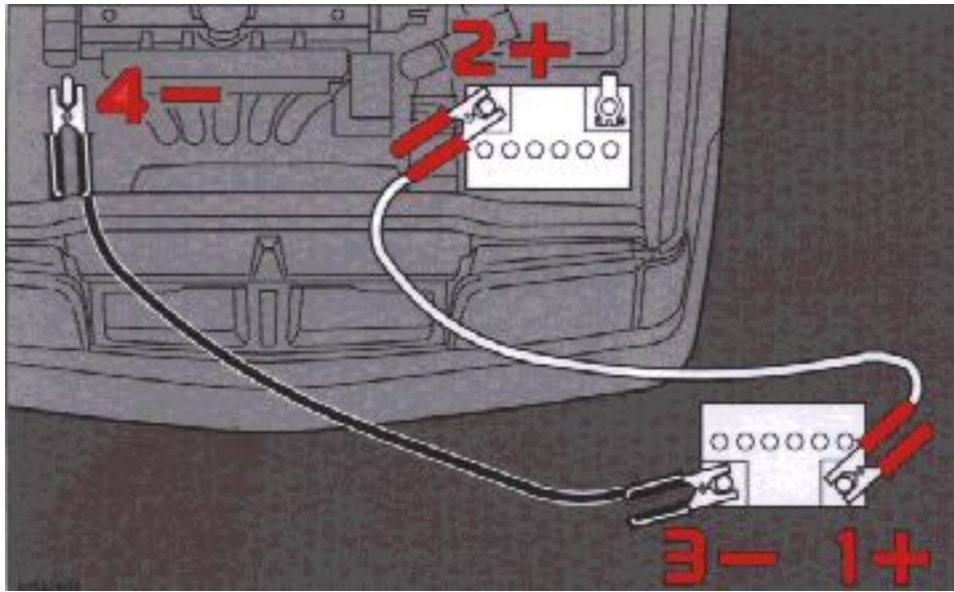

## Jump starting

If the booster battery to be used is in another car, check that the cars are not touching to prevent premature completion of a negative circuit. Note the position of the battery terminals and using jumper cables:

- First connect the booster battery positive (+) terminal (1) to car battery positive (+) terminal (2).
- Then connect booster battery negative (-) terminal (3) to a stationary solid metal part on the engine at a point away from the battery (4).

Do not connect the jumper cable to any part of the fuel system or to any moving parts. Avoid touching hot manifolds.

After the engine has started, first remove the negative (-) terminal jumper cable. Then remove the positive (+) terminal jumper cable.

**CAUTION:** Improper hook-up of jumper cables or use of other than 12-volt batteries could result in damage to equipment and/or the battery.

**WARNING!**

- To reduce the possibility of explosion, never expose the battery to open flame or electric spark.
  - Do not smoke near the battery.
  - Batteries generate hydrogen gas which is flammable and explosive.
  - Battery fluid contains sulfuric acid. Do not allow the battery fluid to contact eyes, skin, fabrics or painted surfaces. If contact occurs, flush the affected area immediately with water. Obtain medical help immediately if eyes are affected.
- Failure to follow the instructions for jump starting can lead to personal injury.

## pg. 4:15 Three-way catalytic converter

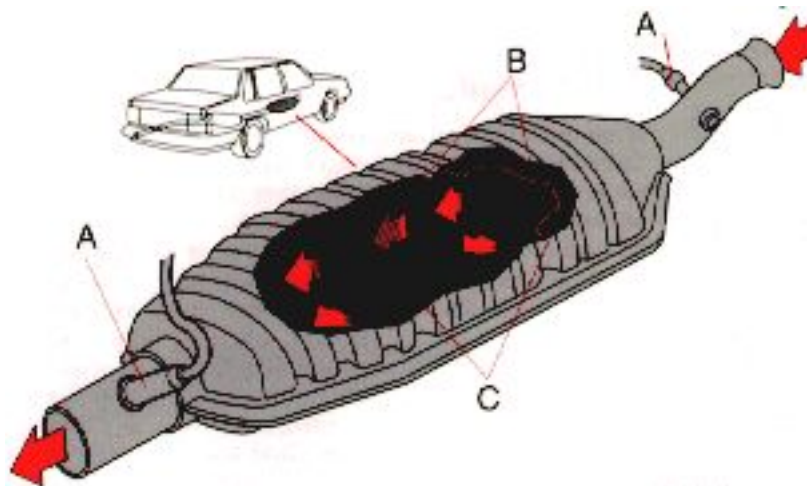

*A - heated oxygen sensors, B - ceramic core, C - insulation*

## Three-way catalytic converter cautions

- Keep your engine properly tuned. Certain engine malfunctions, particularly involving the electrical, fuel or distributor ignition systems, may cause unusually high three-way catalytic converter temperatures. Do not continue to operate your vehicle if you detect engine misfire, noticeable loss of power or other unusual operating conditions, such as engine overheating or backfiring. A properly tuned engine will help avoid malfunctions that could damage the three-way catalytic converter.
- Do not park your car over combustible materials, such as grass or leaves, which can come into contact with the hot exhaust system and cause such materials to ignite under certain wind and weather conditions.
- Excessive starter cranking (in excess of one minute), with an intermittently firing or flooded engine, can cause three-way catalytic converter or exhaust system overheating.
- Remember that tampering or unauthorized modification to the engine or the vehicle may be illegal



and can cause three-way catalytic converter or exhaust system overheating. This includes:

- Altering fuel injection setting or components.
- Adjusting distributor ignition timing beyond specified limits.
- Altering emission system components or location or removing components.
- Repeated use of leaded fuel.

NOTE: Unleaded fuel is required for cars with three-way catalytic converters. A label on the instrument panel and inside the fuel tank filler door will remind owners and filling station attendants of this requirement.

Important! It is unlawful to dispense leaded fuel into any vehicle labelled "unleaded gasoline only".

[pg. 4:16 Brake system](#)

**ABS**

Anti-lock Brake System (ABS)

If the warning lamp lights up there is a malfunction of the ABS system (the standard braking system will however function) and the vehicle should be driven to a Volvo dealer for inspection. The Anti-lock Braking System (ABS) helps to improve vehicle control (stopping and steering) during severe braking conditions by limiting brake lock-up. When the system "senses" impending lock-up, braking pressure is automatically modulated in order to help prevent lockup, which could lead to a skid.

The system performs a self-diagnostic test when the vehicle first reaches a speed of approximately 20 mph (30 km/h). The brake pedal will pulsate several times and a sound may be audible from the ABS control module. This is normal.

To obtain optimal effect from the ABS system, constant pressure should be kept on the brake pedal while the system is modulating the brakes.

The switching of the ABS modulator will be audible and the brake pedal will pulsate at this time. Please be aware that ABS does not increase the absolute braking potential of the vehicle. While control will be enhanced, ABS will not shorten stopping distances on slippery surfaces.

**BRAKE**

Brake circuit malfunction

If one of the brake circuits should malfunction, the red warning light will come on, the pedal stroke increases slightly, the pedal feels softer and extra pressure is required for normal braking. If the light

comes on while driving or braking, stop immediately and check the brake fluid level in the reservoir.

**WARNING!** If the fluid level is below the MIN mark in either section of the reservoir: **DO NOT DRIVE.** Tow the car to a Volvo dealer and have the brake system checked and any leakage repaired.

### Moisture on brake discs and brake pads affects braking

Driving in rain and slush or passing through an automatic car wash can cause water to collect on the brake discs and pads. This will cause a delay in braking effect when the pedal is depressed. To avoid such a delay when the brakes are needed, depress the pedal occasionally when driving through rain, slush etc. This will remove the water from the brakes. Check that brake application feels normal! This should also be done after washing or starting in very damp weather.

### Severe strain on the brake system

The brakes will be subject to severe strain when driving in mountains or hilly areas. The speed is usually low which means that the cooling of the brakes is less efficient than when driving on level roads. To reduce the strain on the brakes, it is advisable not to use the brakes excessively. Instead, shift into a lower gear, position 3 or in some cases, L (automatic transmission) and let the engine help with the braking. Do not forget that, if you are towing a trailer, the brakes will be subjected to greater load than is normal.

### If the brake power-assist does not function

The power assist to the brakes functions only when the engine is running. When the car is moving without the engine running, the brake pedal pressure required to stop the car is increased by 3-4 times and the brake pedal feels stiff.

[pg. 4:17 Trailer towing](#)

When preparing for trailer towing, observe the following:

- Use a trailer hitch which meets Federal Safety Standards for rear end collisions (FMVSS 301-75). For trailer weights exceeding 2000 lbs (908 kg), use only a trailer hitch offered as a Genuine Volvo

accessory.

**NOTE:** Models with automatic transmission are equipped with a transmission oil cooler as standard equipment. This cooler helps prevent overheating of the transmission during times of increased load, as when towing a trailer.

Maximum trailer weight recommended by Volvo is:

- Trailers without brakes : 1540 lbs (700kg)
- Trailers with brakes: 2" (50 mm) ball - 3300 lbs (1500 kg), 1 7/8" (47 mm) ball - 2000 lbs (908 kg).

Observe the legal requirements of the state/province in which the vehicles are registered. All Volvo models are equipped with energy-absorbing shock-mounted bumpers. Trailer hitch installation should not interfere with the proper operation of this bumper system.

Trailer towing does not normally present any particular problems, but take into consideration:

- Increase tire pressure to recommended full. See section "Wheels and tires".
- Recommended hitch tongue load is 110 lbs (50 kg) for trailer weights below 2,650 lbs (1,200 kg) and 165 lbs (75 kg) for trailer weights above 2,650 lbs (1,200 kg). For trailer weights between 2,650 - 3,300 lbs (1,200 - 1,500 kg) a top speed of 50 mph (80 km/h) should never be exceeded.
- Engine and transmission are subject to increased loads. Therefore, engine coolant temperature should be closely watched when driving in hot climates or hilly terrain. Use lower gear and turn off air conditioner if the temperature gauge pointer enters the red range.
- Avoid overload and other abusive operation.
- Hauling a trailer affects handling, durability, and economy.
- It is necessary to balance trailer brakes with the towing vehicle brakes to provide a safe stop (check and observe State/Local regulations).
- Do not connect the trailer's brake system directly to the vehicle's brake system.
- More frequent vehicle maintenance is required.
- Remove the ball and drawbar assembly when the hitch is not being used.
- Volvo recommends the use of synthetic engine oil when towing a trailer over long distances or in mountainous areas.

**NOTE:** Refer to section "Automatic transmission" for additional trailer hauling tips.

**WARNING!**

- Bumper-attached trailer hitches must not be used on Volvos, nor should safety chains be attached to the bumper.
- Trailer hitches attaching to the vehicle rear axle must not be used.
- Never connect a trailer's hydraulic brake system directly to the vehicle brake system, nor a trailer's lighting system directly to the vehicle lighting system. Consult your nearest authorized Volvo dealer for correct installation.

[pg. 4:18 Winter driving](#)

## Cold weather precautions

If you wish to check your car before the approach of cold weather, the following advice is worth noting:

- Make sure that the engine coolant contains at least 50 percent antifreeze: that is, 3.7 qts. (3.5 liters) Volvo Genuine Coolant/Antifreeze. This gives protection against freezing down to -31°F (-35°C). See section "Coolant". The use of "recycled" antifreeze is not approved by Volvo. Different types of antifreeze may not be mixed.
- Try to keep the fuel tank well filled - this prevents the formation of condensation in the tank. In addition, in extremely cold weather conditions it is worthwhile to add fuel line de-icer before refueling.
- The viscosity of the engine oil is important. Oil with low viscosity (thinner oil) improves cold-weather starting as well as decreasing fuel consumption while the engine is warming up. For winter use, 5W-30 oil, particularly the synthetic type, is recommended. Be sure to use good quality oil but do not use this cold-weather oil for hard driving or in warm weather. See section "Engine oil" for more information.
- The load placed on the battery is greater during the winter since the windshield wipers, lighting, etc. are used more often. Moreover, the capacity of the battery decreases as the temperature drops. In very cold weather, a poorly charged battery can freeze and be damaged. It is therefore advisable to check the state of charge more frequently and spray an anti-rust oil on the battery posts.
- Volvo recommends the use of snow tires on all four wheels for winter driving - see section "Wheels and tires".
- To prevent the washer fluid reservoir from freezing, add washer solvents containing antifreeze (see page 8:15 for the location of the washer fluid reservoir). This is important since the dirt is often splashed on the windshield during winter driving, requiring the frequent use of the washers and wipers. The Volvo Washer Solvent should be diluted as follows:
  - Down to 14°F (-10°C): 1 part anti-freeze and 4 parts water
  - Down to 5°F (-15°C): 1 part anti-freeze and 3 parts water
  - Down to 0°F (-18°C): 1 part anti-freeze and 2 parts water
  - Down to -18°F (-28°): 1 part anti-freeze and 1 part water

- When driving in temperatures below 15° F (-10° C), we recommend the use of Volvo's radiator guard to help the engine reach normal operating temperature as quickly as possible. This guard should not be used when towing a trailer.
- Use Volvo Teflon Lock Spray in the locks.

NOTE: Avoid the use of de-icing sprays as they can cause damage to the locks.

#### pg. 4:19 Long distance trips, City driving

### Before a long distance trip

It is always worthwhile to have your car checked at a Volvo dealer before driving long distances. Your dealer will also be able to supply you with bulbs, fuses, spark plugs and wiper blades for your use in the event that problems occur.

If you prefer to check the car yourself, please note the following:

- Check that the engine runs smoothly and that fuel consumption is normal.
- Check engine oil, coolant levels, and for possible fuel leakage.
- Check transmission oil level.
- Check condition of drive belts.
- Check state of charge of battery.
- Examine tires carefully (the spare tire as well), and replace those that are worn. Check tire pressures.
- The brakes, front wheel alignment, and steering gear should be checked by your Volvo dealer only.
- Check all lights, including high beams.
- Reflective warning triangles are legal requirement in some countries.
- Have a word with your Volvo dealer concerning engine adjustments if you intend to drive in countries where it may be difficult to obtain correct fuel.
- Consider your destination. If you will be driving through an area where snow or ice are likely to occur, consider snow tires.

### City driving

City driving can be a severe driving condition. Low operating speeds, long periods of idling combined with high operating temperatures, air conditioning usage, etc. will make more frequent servicing necessary (twice a year or at 5,000 mile ((8,000 km)) intervals).



[Contents](#) | [Top of Page](#)

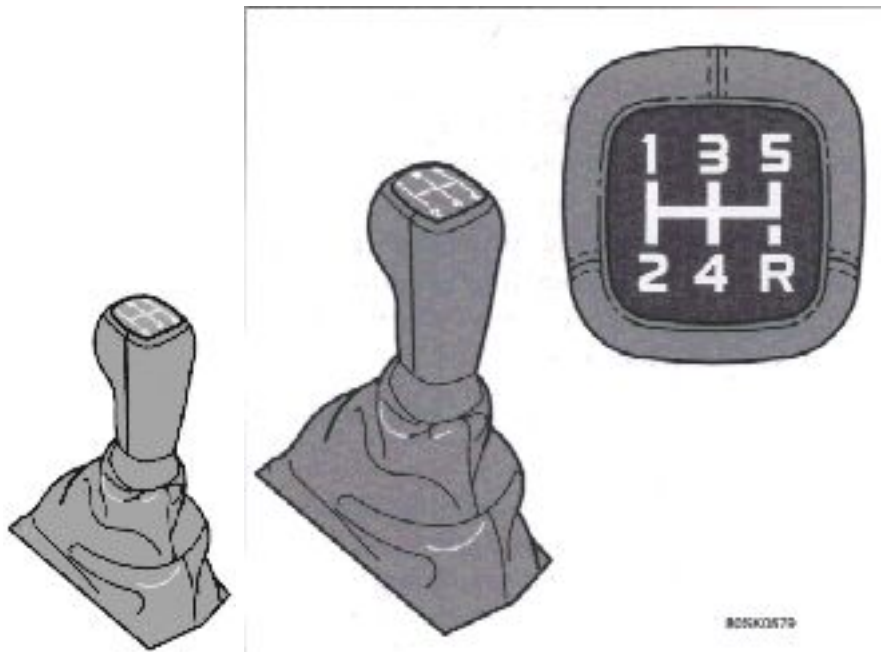

## Shift positions

Depress the clutch pedal completely when changing gears.

Remove your foot from the clutch pedal while driving.

Overdrive (5th gear) should be used as often as possible to help improve fuel economy. This gear can be engaged at speeds above approx. 50 mph (80 km/h).

**CAUTION:** Follow the shift pattern indicated on the gear shift knob when shifting up (e.g. do not shift directly from 2nd to 5th gear) to help avoid excessive wear on the transmission.

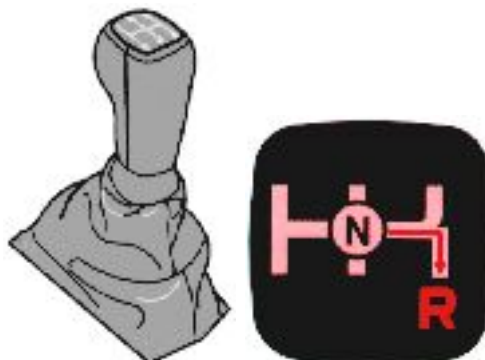

## Engaging reverse gear

The gear lever must first be moved to neutral in order to engage reverse gear.

**CAUTION:** Be careful that you do not inadvertently engage reverse while moving forward.

[pg. 4:7 Automatic transmission](#)

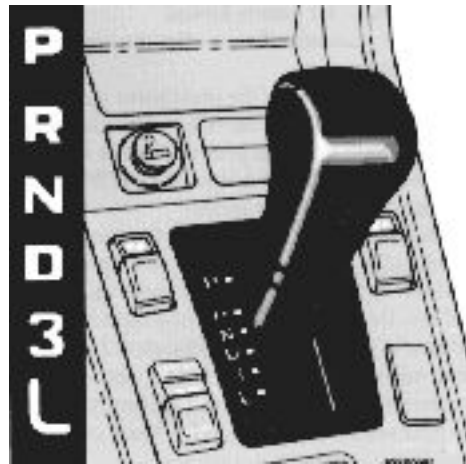

### P (Park)

Use this position when starting the engine or parking the car.

Never use P while car is in motion.

The parking brake should also be used when parking on grades.

The gear selector is mechanically locked in the P position (SHIFT LOCK).

To release the selector, start the engine and depress the brake pedal. If it is necessary to manually release the gear selector, see page 6:17 for instructions.

**WARNING!** Never leave the car when the engine is running. If, by mistake, the gear selector is moved from P, the car may start moving.

### R (Reverse)



Never engage R while the car is moving forward.

## N (Neutral)

Neutral = no gear engaged. Use the parking brake. The engine can be started with the gear selector in this position.

## D (Drive)

D is the normal driving position and should be used as often as possible to help improve fuel economy. When modes E or S are selected, upshift and downshift of the forward gears occur automatically and are governed by accelerator pedal position and vehicle speed.

### WARNING!

- Never select P or R while the car is in motion.
  - When initially selecting positions D, 3, L or R, your right foot should press firmly on the brake pedal to ensure that the car is standing still with the engine idling.
  - The gear selector should not be downshifted to L at speeds above 75 mph (125 km/h). \*
- \* Always observe posted speed limits!

## 3 (Intermediate position)

Automatically shifts up and down between 1st, 2nd, and 3rd gears when in driving modes E or S. There is no upshift from 3rd gear. Position 3 can be used for driving in hilly terrain, for towing trailers or for increased engine braking power.

## L (Low position)

No upshift can occur when L is engaged. Select position L for driving in first and second gears. Use this position to select low gear with no upshift, e.g. when ascending and descending steep grades.

## Kick-down

Automatic shift to a lower gear (kick-down) is achieved by depressing the accelerator pedal fully and briskly. An upshift will be achieved when approaching the top speed for a particular gear or by releasing the accelerator pedal slightly. Kick-down can be used for maximum acceleration or when passing at highway speeds.

## "Lock-up"

The transmission has a "lock-up" function which reduces engine speed and saves fuel. "Lock-up" can sometimes be felt as an additional gear change.

[pg. 4:8 Automatic transmission \(cont.\)](#)

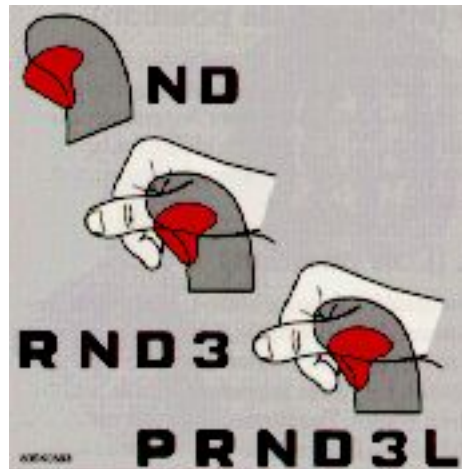

## Shift gate positions

The gear selector can be moved freely between N and D. Selections of other positions are obtained by depressing the selector knob prior to moving the selector.

Slightly depressing the selector knob allows selection of positions R, N, D, 3 and L. Fully depressing the selector knob allows selection of position P. This is also necessary when initially bringing the selector out of position P. Fully depressing the selector knob permits shifting freely between all positions.

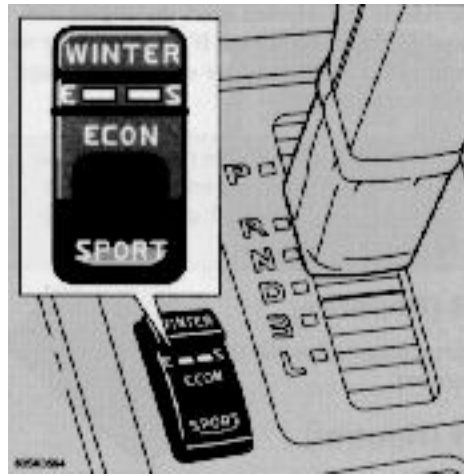

## Mode selector

The push-buttons to the left of the gear lever are for selection of modes. E, S, and W. The desired mode can be selected at any time, including while the car is moving.

### WINTER

#### Winter mode

This mode may be selected for starting/moving off on slippery roads.

In this mode:

- \* In position D, the gearbox starts in 3rd gear and changes up to 4th gear.
- \* In position 3, 2nd gear is locked and there is no change up to 3rd gear.

In position L, 1st gear is locked.

- \* These positions always offer the kick-down function.

The indicator lamp in the instrument panel  lights up when Winter mode is selected (the lamp will also light up if the gear selector is in position 3, 2 or L). Press button WINTER in order to disengage this mode.

When Winter mode is disengaged, the gearbox automatically reverts to the previously selected S or E mode. If the indicator lamp  begins to flash, this is an indication of a fault in the automatic gearbox. The Malfunction Indicator lamp will also light up if a fault is detected. Please contact your Volvo dealer if this occurs.

**CAUTION:** Driveability and fuel economy will be adversely affected by prolonged driving in winter mode. Volvo recommends using this mode only when starting in extremely slippery conditions.

**ECON**

## Economy Mode

This mode is used for normal driving. The gearbox changes gears at a lower engine speed to achieve the best possible fuel consumption.

**SPORT**

## Sport Mode

This mode is adapted to "sporty" driving characteristics. The transmission upshifts at higher engine speeds and less accelerator pedal pressure is required to initiate a downshift.

[pg. 4:9 Automatic transmission \(cont.\)](#)

## Special tips - automatic transmission

- For driving down steep hills and when driving for prolonged periods at low speeds, position L should be selected. Avoid, however, repeated changes since this can cause overheating of the transmission oil. For driving on long continuous uphill gradients, select position 3.
- The transmission may shift down automatically (ECONOMY mode only) on certain downgrades if no pressure is exerted on the accelerator pedal, to help maintain constant vehicle speed.
- Do not hold the car stationary on an incline by using the accelerator pedal. Instead, apply the hand brake (parking brake). This prevents the transmission oil from becoming overheated.
- When towing a trailer, select shift position 3.
- The (E)conomy mode should be selected when the cruise control is engaged.
- While towing a trailer in hilly terrain, do not drive continuously at engine speeds above 4500 rpm to help avoid high engine oil temperatures.

[pg. 4:10 Points to remember](#)

## Cooling system

The risk for engine overheating is greatest, especially in hot weather, when:

- towing a trailer up steep inclines for prolonged periods at wide open throttle and low engine rpm.
- stopping the engine suddenly after high speed driving (so-called "after-boiling" can occur).

- To avoid overheating, the following rules should be followed:
- Do not drive for prolonged periods at engine speeds above 4500 rpm if you are towing a trailer in hilly terrain.
- Reduce speed and downshift when towing a trailer up long, steep inclines. The risk of overheating can be reduced by switching off the air conditioning system for a short time.
- Do not let the engine idle unnecessarily for prolonged periods.
- Do not mount auxiliary lamps in front of the grill.

When the risk of overheating is imminent, or in the event of overheating (the temperature gauge goes repeatedly into, or stays continually in, the red section), the following precautions should be taken:

- Switch off the air conditioning system.
- Stop the car and put the gear lever into neutral. Do not stop the engine!
- Switch the heater to full (maximum) position. Increase the engine speed to approx. 2000 rpm (twice idling speed) until the temperature begins to drop.

**WARNING!** Do not remove coolant expansion tank cap.

See "Coolant" to check and top-up the coolant level if necessary.

**CAUTION:** Drive slowly and carefully if going through standing water (i.e. flooded roadways, etc.) Damage to engine could result if excess water is ingested through the air intake system. Never drive the vehicle in water deeper than 1 foot (300 mm). See flood warning on page 3:7.

**WARNING!** Do not drive with trunk lid or tailgate open! Poisonous exhaust gases may enter via the open trunk lid or tailgate.

If the trunk lid/tailgate must be kept open for any reason, proceed as follows:

- Close the windows.
- Set the ventilation system control to air flow to floor, windshield and side windows and blower control to its highest setting.

## Electrical system

When replacing the battery or when carrying out work involving the electrical system, the following should be observed:

- A battery connection to the wrong terminal will damage the diodes. Before connections are made, check the polarity of the battery with a voltmeter.
- If booster batteries are used for starting, they must be properly connected to minimize the risk of the diode being damaged. For correct connection, see "Jump starting" section.
- Never disconnect the battery circuit (for example, to replace the battery) while the engine is running,

as this will immediately ruin the generator. Always make sure that all the battery connections are properly tightened.

- If any electrical welding work is performed on the vehicle, the ground lead and all the connecting cables of the generator must be disconnected and the welder cables placed as near the welding points as possible.
- The radio must be turned off before the battery is disconnected.
- The anti-theft code must be re-entered before the radio will function properly.
- The electrical system in your car is designed to accommodate Volvo accessories. It also has an accessory connector located beneath the dashboard on the driver's side.

[pg. 4:11 Points to remember \(cont.\)](#)

## Weight distribution affects handling

At the specified curb weight your car has a tendency to understeer, which means that the steering wheel has to be turned more than might seem appropriate for the curvature of a bend. This ensures good stability and reduces the risk of rear wheel skid. Remember that these properties can alter with the vehicle load. The heavier the load in the trunk (max. 220 lbs, 100 kg), the less the tendency to understeer.

## Handling, roadholding

Vehicle load, tire design and inflation pressure all affect vehicle handling. Therefore, check that the tires are inflated to the recommended pressure according to the vehicle load. See "Tire pressure" section. Loads should be distributed so that capacity weight or maximum permissible axle loads are not exceeded.

**WARNING!** It is recommended that tires of the same make and dimensions be used on all four wheels (including the use of snow tires). Do not use bias ply tires as this will adversely alter vehicle handling characteristics.

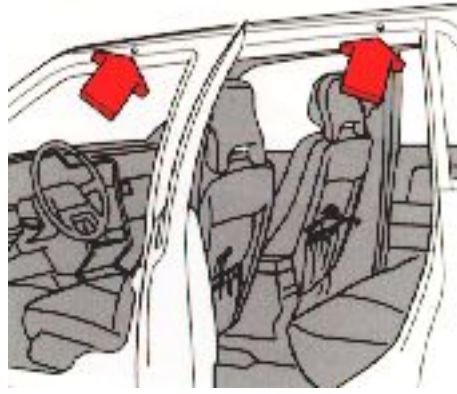

*Holes for roof rack*

## Roof racks

Roof racks are available as Volvo accessories. Observe the following points when in use:

- Avoid single-point loads. Distribute the load evenly.
- Place heavier cargo at the bottom of the load.
- Observe that the center of gravity and handling are influenced by load weight.
- Increasing load size increases wind resistance and thus adversely affects fuel economy.
- Anchor the cargo correctly with appropriate cords.
- Drive carefully. Avoid rapid starts, fast cornering and hard braking.
- Max. roof load is 220 lbs (100 kg) when Volvo approved roof racks are attached to the points indicated in the illustration. For permanent roof racks, check the manufacturer's weight specifications.

**WARNING!** An extra mat on the driver's floor can cause the accelerator pedal to catch. Check that the movement of the accelerator pedal is not impeded. Not more than one protective floor covering may be used at one time.

[pg. 4:12 Emergency towing \(pulling of vehicle\)](#)

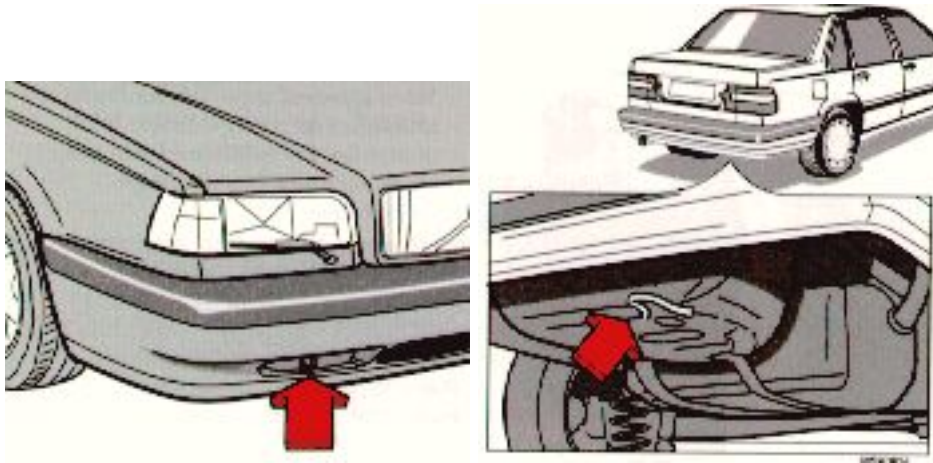

*Front eyelet    Rear eyelet*

Precautionary steps to observe when the car is in tow

- Steering must be unlocked.
- Please check with state and local authorities before attempting this type of towing, as vehicles being towed are subject to regulations regarding maximum towing speed, length and type of towing device, lighting, etc.
- Remember that power brake and power steering assists will not be available when engine is inoperative. Brake pedal pressure required is 3 - 4 times above normal and greater steering effort must be exerted.

Automatic transmissions only:

- Gear selector in position N. Check transmission oil level (see section titled "Transmission oil").
- Maximum speed: 20 mph (30 km/h).
- Maximum distance with front wheels on ground: 20 miles (30 km).
- If the battery is dead, it is not possible to release the gear selector by pressing the brake pedal. Release the gear selector manually, by pressing the OVERRIDE button near the base of the gear selector.

**CAUTION:** The towing eyelets must not be used for pulling another vehicle out of a ditch or any similar purpose involving severe strain.

Do not attempt to start the car by pushing or pulling it as damage to the three-way catalytic converter can result.

[pg. 4:13 Vehicle towing information](#)

Only use flat bed equipment \*



**CAUTION:**

- Sling-type equipment applied at the front will damage radiator and air conditioning lines.
- It is equally important not to use sling-type equipment at the rear or apply lifting equipment inside the rear wheels; serious damage to the rear axle may result.

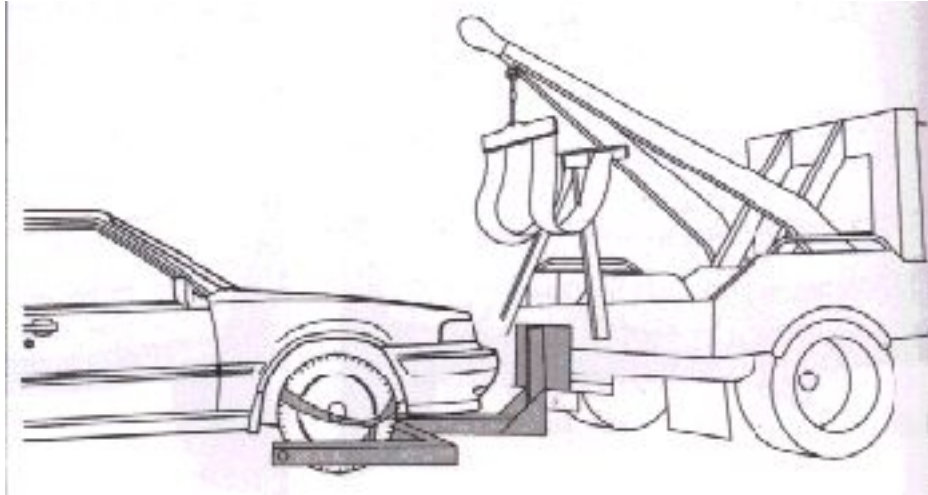

The car should be towed with the rear wheels on the ground, if at all possible. If it is absolutely necessary to tow the vehicle with the front wheels on the ground, please refer to the towing information on the previous page.

\* If wheel lift equipment must be used, please use extreme caution to help avoid damage to the car.



[Contents](#) | [Top of Page](#)

## Wheels and tires

[pg. 5:1 Wheels and tires](#)

### Wheels and tires

The handling and riding comfort of the vehicle is dependent on the inflation pressure and the type of tires fitted. Read the following pages carefully.

[5:2](#) General information, Wear indicator, Tire economy, Flat spots

[5:3](#) Snow chains, Winter tires

[5:4](#) Inflation pressure

[pg. 5:2 Wheels and tires \(cont.\)](#)

### General information

Your vehicle is equipped with tires according to the tire information label located on the rear facing side of the right front door.

The following is an example of a tire designation code:

195 = tire width in mm.

60 = tire profile. This is the relationship (in percent) between the section height and the width of the tire.

R = radial tires.

15 = diameter in inches.

The tires have good road holding characteristics and offer good handling on dry and wet surfaces. It should be noted however that the tires have been developed to give these features on snow/ice-free surfaces. Certain models are equipped with "all-season" tires, which provide a somewhat higher degree of road holding on slippery surfaces than tires without the "all-season" rating. However, for optimum road holding on icy or snow covered roads - we recommend suitable winter tires on all four wheels. When replacing tires, be sure that the new tires are the same size designation, type (radial) and preferably from the same manufacturer, on all four wheels. Otherwise there is a risk of altering the car's

road-holding and handling characteristics.

NOTE: When storing wheel/tire assemblies (e.g. winter tires and wheels), either stand the assemblies upright, or suspend them off the ground. Laying wheel/tire assemblies on their sides for prolonged periods can cause wheel and/or tire damage.

### Wear indicator

The tires have a so-called "wear indicator" in the form of a number of narrow strips running across or parallel to the tread. When approx. 1/16" (1.6 mm) is left on the tread, these strips show up and indicate that the tire should be replaced.

Tires with less than 1/16" (1.6 mm) tread have a very poor grip in rain or snow.

When replacing worn tires, it is recommended that the tire be identical in type (radial) and size as the one being replaced. Using a tire of the same make (manufacturer) will prevent alteration of the driving characteristics of the vehicle.

To improve tire economy:

- Maintain correct tire pressure.
- Drive smoothly: avoid fast starts, hard braking and tire screeching.
- Tire wear increases with speed.
- Correct front wheel alignment is very important.
- Unbalanced wheels impair tire economy and driving comfort.
- If the wheels are rotated, they should be kept on the same side of the car so that they revolve in the same direction as prior to rotation.
- Hitting curbs or potholes can damage the tires and/or wheels permanently.

### Flat spots

All tires become warm during use. After cooling, when the vehicle is parked, the tires have a tendency to distort slightly, forming flat spots. These flat spots can cause vibrations similar to the vibrations caused by imbalanced wheels.

They do, however, disappear when the tire warms up. The degree to which the flat spots form depends on the type of cord used in the tire. Remember that, in cold weather, it takes longer for the tire to warm up and consequently longer for the flat spot to disappear.

## Snow chains

Snow tire chains can be used on your Volvo with the following restrictions:

- Snow chains should be installed on front wheels only.
- Snow chains can be used on the tires and wheels provided as original production equipment with your Volvo.

If accessory, aftermarket or "custom" tires and wheels are installed and are of a size different than the original tires and wheels, chains in some cases CANNOT be used. Sufficient clearances between chains and brakes, suspension and body components must be maintained.

- Some strap-on type chains will interfere with brake components and therefore CANNOT be used.

### CAUTION:

- Check local regulations regarding the use of snow chains before installing.
- Always follow the chains manufacturer's installation instructions carefully. Install chains as tightly as possible and re-tighten periodically.
- Never exceed the chain manufacture's specified maximum speed limit. (Under no circumstances should that limit be higher than 30 mph (45 km/h).
- Avoid bumps, holes or sharp turns when driving with snow chains.
- The handling of the vehicle can be adversely affected when driving with chains. Avoid fast or sharp turns as well as locked wheel braking.

## Snow tires, studded tires \*

Tires for winter use:

Owners who live in or regularly commute through areas with sustained periods of snow or icy driving conditions are strongly advised to fit suitable winter tires to help retain the highest degree of traction. It is important to install winter tires on all four wheels to help retain traction during cornering, braking and accelerating. Failure to do so could reduce traction to an unsafe level or adversely affect handling. Do not mix tires of different design as this could also negatively affect overall tire road grip. Volvo recommends 185/65 R15 winter tires on 15" wheels on all 850 models including models equipped with 16" wheels.

Winter tires wear more quickly on dry roads in warm weather. They should be removed when the winter driving season has ended.

Studded tires should be run-in 300-600 miles (500-1000 km) during which the car should be driven as smoothly as possible to give the studs the opportunity to seat properly in the tires. The car tires should have the same rotational direction throughout their entire lifetime. In other words, if you wish to rotate the wheels, make sure that the same wheels are always on the same side of the car.

NOTE: Please consult state or local regulations restricting the use of studded winter tires before installing such tires.

\* Where permitted

[pg. 5:4 Wheels and tires \(cont.\)](#)

## Checking and correcting tire pressure

- Check the tire pressure when refueling.
- The tire pressure should be corrected only when the tires are cold.
- With warm tires, correct only when the pressure is too low. The tire temperature rises after driving just a few miles.

## Vehicle Loading

The tires on your Volvo will perform to specifications at all normal loads when inflated as recommended on the tire information label located on the inside of the fuel filler flap. This label lists both the tire and vehicle design limits.

Do not load your car beyond the load limits indicated.

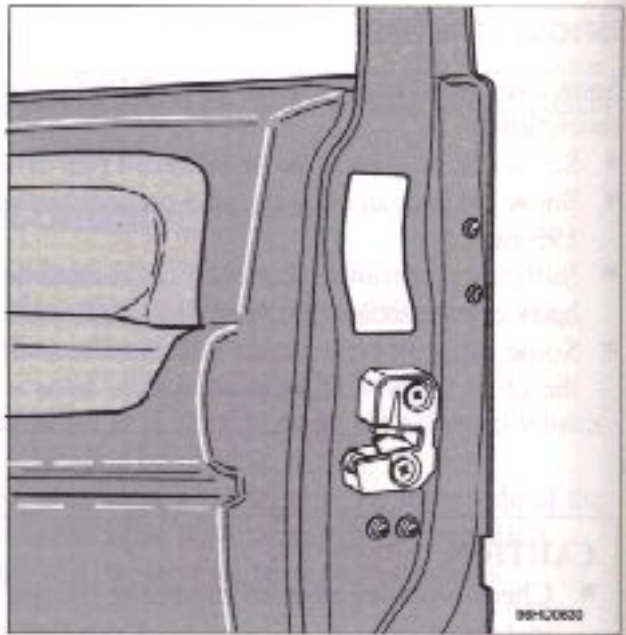

*Located on rear edge of right front door*

VEHICLE CAPACITY WEIGHT	OCCUPANTS		COLD TIRE PRESSURE		
	FR	RR	TOTAL	FRONT	REAR
MAX (LOAD)	2 3 5				PSI
RECOMMENDED FOR FUEL ECONOMY					
OPTIONAL TIRE SIZES:					
TIRE SIZE	2 1 3				PSI
* SEE APT FOR TIRE PRESSURE INFORMATION AND TO BE REINFORCED TO LOADS					
	SIZE	SPRNG	DRY	WET	PSI
SEE OWNER'S MANUAL FOR ADDITIONAL INFORMATION					
<b>VOLVO</b>					

*(Sample tire pressure label)*

*Tire pressure label*



[Contents](#) | [Top of Page](#)

## In case of emergency

pg. 6:1 In case of an emergency

### In case of an emergency

Even if you maintain your car in good running condition, there is always the possibility that something might go wrong and prevent you from driving, such as a punctured tire, blown fuse or bulb, etc. For additional information, see section "ON CALL Road Assistance".

[6:2](#) Wheel changing

[6:4](#) Spare tire

[6:5](#) Replacing bulbs

[6:13](#) Replacing fuses

[6:15](#) Replacing wiper blades

[6:16](#) Service diagnosis (Troubleshooting)

pg. 6:2 Wheel changing



*Loosen wheel bolts*

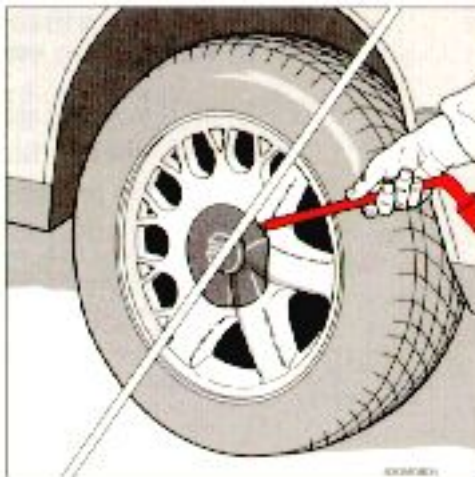

*Insert flat end of lug wrench and turn      Pull straight out*



80148150

### Changing a wheel

The spare wheel is located under the carpet on the trunk floor. The jack and crank are secured in the wheel recess.

- Engage the parking brake.
- Put the gear selector in (P)ark (automatic) or in Reverse (manual).
- Remove the wheel cap (where applicable) using the lug wrench in the tool kit.
- With the car still on the ground, use the lug wrench to loosen the wheel bolts 1/2 - 1 turn. Turn the bolts counterclockwise to loosen.
- Fold out the crank handle on the jack by pressing the nob on the handle downward. To attach the jack, refer to the illustration on the following page.

NOTE: To avoid excessive wear and the necessity of rebalancing, mark and reinstall wheels in same location and position as before removal. To lessen the chance of imbalance, each wheel hub is equipped with a guide stud\* to ensure that a removed wheel can be reinstalled in its original position (as when changing over to winter tires/wheels).

\* The guide stud is not visible from the outside of the wheel on turbo models.

pg. 6:3 Wheel changing (cont.)

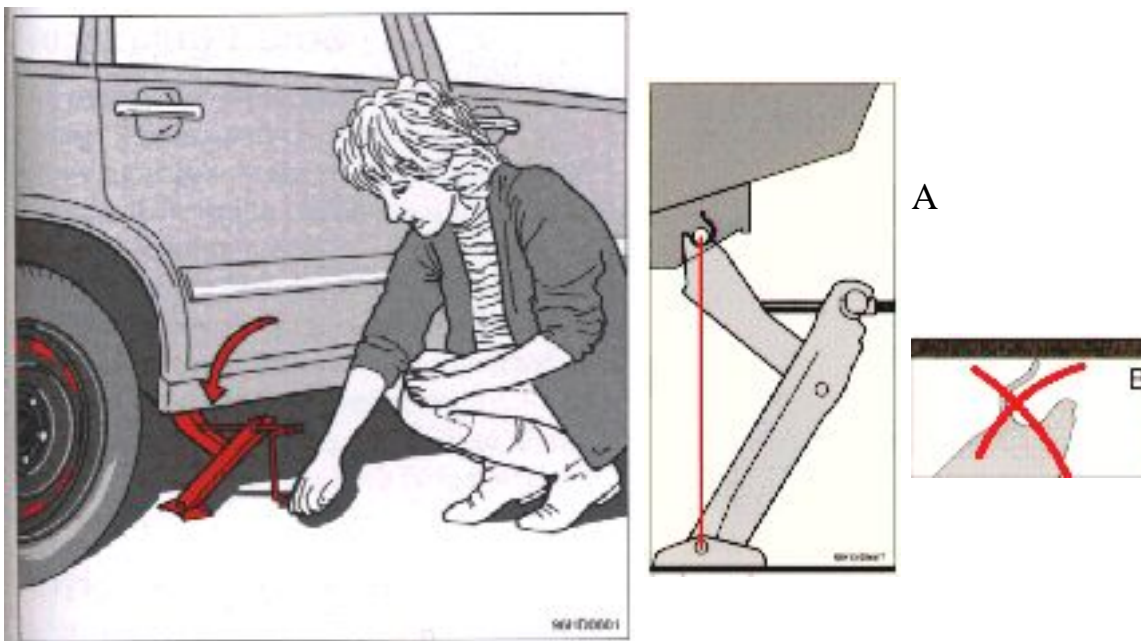

*Jack attachment*



There is a jack attachment located in the center on each side of the car. Position the jack on the bar in the attachment as shown in illustration A above and crank while simultaneously guiding the base of the jack to the ground. The base of the jack must be flat on a level, firm, non-slippery surface. Before raising the car, check that the jack is still correctly positioned in the attachment. Raise the vehicle until both wheels on the side of the car where the jack is attached are lifted off the ground. Unscrew the wheel bolts completely and carefully remove the wheel so as not to damage the thread on the studs.

## Installing the wheel

Clean the contact surfaces on the wheel and hub. Lift the wheel and place it on the hub. Make sure that you align the wheel with the guide stud on the wheel hub prior to installation. Install the wheel bolts cross-wise (see illustration) and tighten by turning lightly clockwise. Lower the vehicle to the ground and alternately tighten the nuts to 81 ft. lbs. (110 Nm). Install the wheel cap (where applicable).

### WARNING!

- The jack's attachment must engage the bar in the jack attachment (A). The car's weight must not rest on the jack's attachment (B).
- Be sure the jack is on a firm, level, non-slippery surface.
- Never allow any part of your body to be extended under a car supported by a jack.
- Use the jack intended for the car when replacing a wheel. For any other job, use stands to support the end of the car being worked on.
- Apply the parking brake, select position P (automatic transmission) or Reverse gear (manual transmission).
- Block the wheels standing on the ground, use rigid wooden blocks or large stones.
- The jack should be kept well-greased.

**CAUTION:** Correct tightening torque on wheel bolts must be observed. The wheel bolts should never be greased or lubricated. Extra long, chromed wheel bolts may not be used on vehicles equipped with steel wheels.



*Correct tightening order for wheel bolts*

pg. 6:4 Spare tire

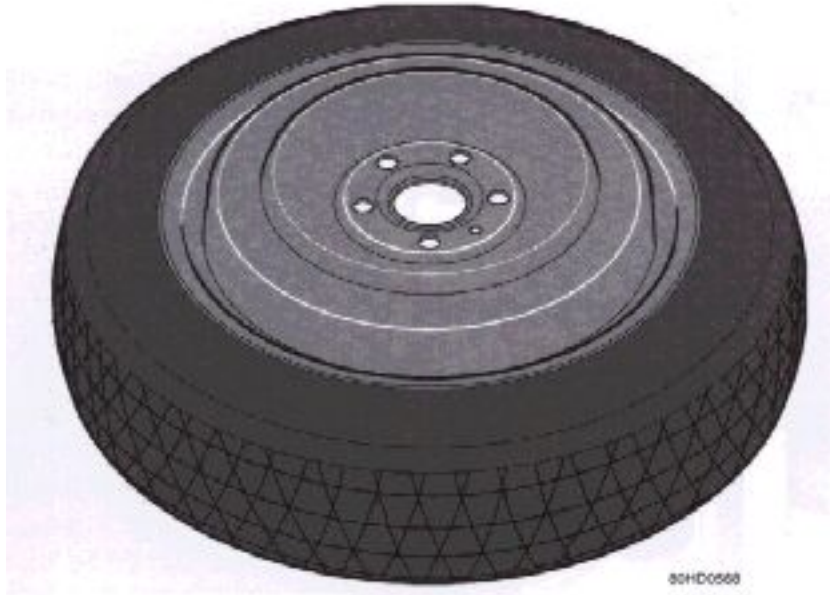

### Temporary Spare

The spare tire of your car is what is called a "Temporary Spare". It has the following designation: T115/70 R15.

Recommended tire pressure (see decal on fuel filler flap) should be maintained irrespective of which position on the car the Temporary Spare tire is used on.

In the event of damage to this tire, a new one can be purchased from your Volvo dealer.

#### **WARNING!**

Current legislation prohibits the use of the "Temporary Spare" tire other than as a temporary replacement for a punctured tire. In other words, it must be replaced as soon as possible by a standard tire. Roadholding, etc., may be affected with the "Temporary Spare" in use. Do not, therefore, exceed 50 mph (80 km/h).



[Contents](#) | [Top of Page](#)

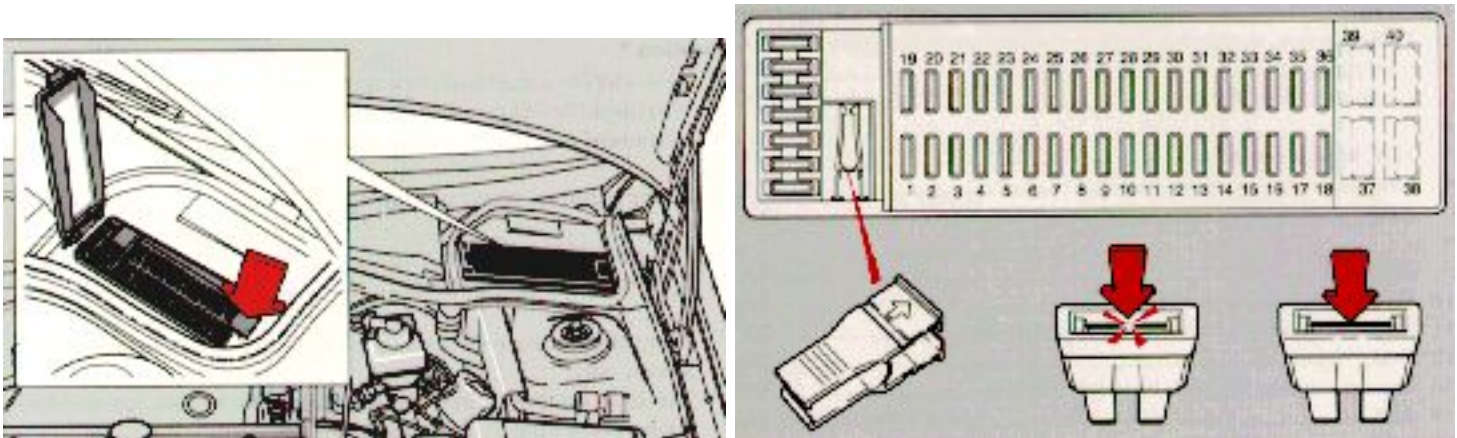

*Fuse removal tool Defective fuse Intact fuse*

## Replacing fuses

If an electrical component fails to function, it is likely that a fuse has blown due to a temporary circuit overload.

The fuse box is located in the engine compartment (see illustration) and can be opened by lifting the cover.

A label on the inside of the cover indicates the amperage and the electrical components that are connected to each fuse.

The easiest way to see if a fuse is blown is to remove it. Pull the fuse straight out. From the side, examine the curved metal wire to see if it is broken. If so, put in a new fuse of the same color and amperage (written on the fuse). Spare fuses are stored in a compartment in the fuse box.

If fuses burn out repeatedly, have the electrical system tested at a Volvo dealer.

If you find it difficult to remove a fuse, you will find a special fuse tool clipped in the fuse box.

## Location \* Amperage

- 1 Fuel injection, distributor ignition system, automatic gearbox 15A
- 2 Fuel pump, alarm 15A
- 3 Interior courtesy lights 10A
- 4 –
- 5 ECC blower (speed 4) 30A
- 6 Central locking system 25A
- 7 Audio system 15A
- 8 Air pump system 40A
- 9 ABS, TRaction Control System 30A
- 10 Electrically heated rear seat 15A
- 11 Electrically heated rear window and side-door mirrors 30A
- 12 Brake lights 10A
- 13 Hazard warning flashers, headlight flashers 15A
- 14 ABS, TRaction Control System 30A
- 15 OBD socket, courtesy lights, door open warning lights, remote operated central locking system 10A
- 16 Power antenna, electrical connector for trailer, accessories 30A
- 17 Key reminder 10A
- 18 Front fog lights 15A
- 19 Left high beam 15A
- 20 Right high beam, high beam indicator light 15A
- 21 Left low beam 15A
- 22 Right low beam 15A
- 23 Left parking lights, license plate lights 10A
- 24 Right parking lights 10A
- 25 Rear fog light, rear fog light indicator light 10A
- 26 Heated front seats, power side-view mirrors 25A
- 27 Backup lights, direction indicators 15A
- 28 Cruise control, heated rear window, seat belt reminder light, bulb failure warning sensor, shiftlock 10A
- 29 ABS, TRaction Control System 15A
- 30 Cigarette lighter 10A
- 31 ECC blower (speeds 1-3), ECC, AC-compressor 25A
- 32 Audio system, remote controlled central locking 10A

## Location \* Amperage

33 Power seat, OBD socket, rear window wiper/washer (wagons) 15A

34 Windshield/headlight wipers/washers, horn 25A

35 Instrument panel lights, power sun roof 10A

36 –

37 Power windows, power sun roof AUT/CB \*\*

38 –

39 Power seat (driver's side) AUT/CB \*\*

40 –

\* Some of the equipment/systems listed may be available on certain models only.

\*\* This is an automatic circuit breaker located in the fuse box and does not normally need to be replaced.

For more detailed information concerning function and location of relays, fuses, etc., refer to the Volvo Service Manuals. These can be purchased directly using the Service Literature Brochure/Order Form or through your Volvo dealer.

[pg. 6:15 Replacing wiper blades](#)

## Replacing wiper blades

Lift the wiper arm off the windshield and hold the blade at right angles to the arm. Pinch the end of the plastic clip located at the back of the arm.

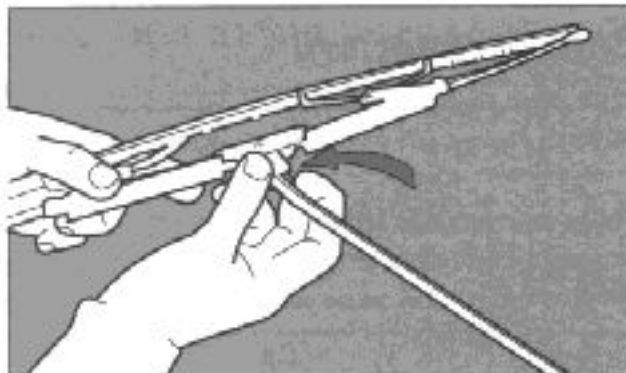

Slide the wiper blade along the arm to release it from the hook.

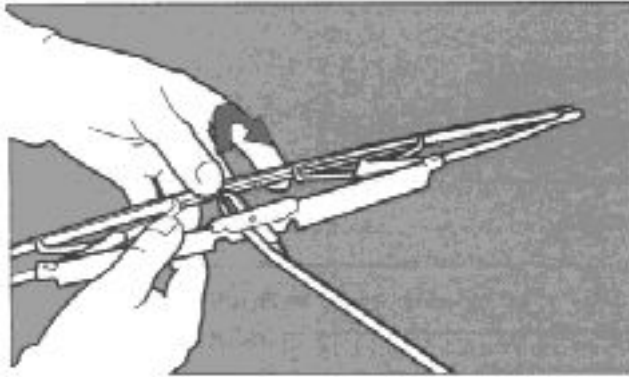

Install the new blade (installation is the reverse of removal) and make sure that it is properly attached to the wiper arm.

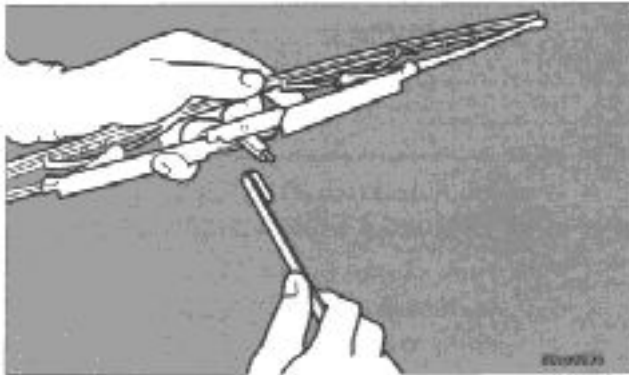

**NOTE:** For reasons of safety, you should change the windshield wiper blades as soon as they start to leave marks on the windshield or fail to wipe efficiently and cleanly.

To obtain maximum lifetime from a set of wiper blades, clean them with a stiff-bristle brush and warm, soapy water as part of a normal car wash.

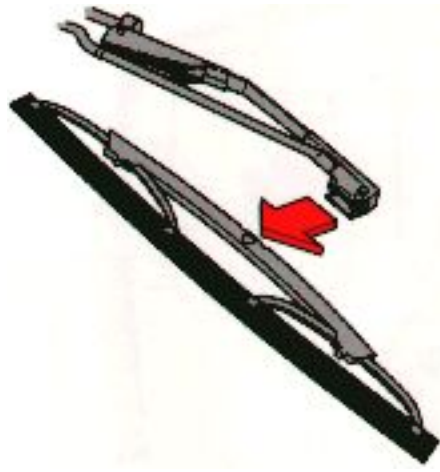

### Replacing headlight wiper blades (certain models)

Pull the wiper blade in the direction indicated by the arrow in the illustration to remove it. Press the new blade into place. Check that the new blade is properly attached to the wiper arm.

[pg. 6:16 Service diagnosis](#)

The diagnoses outlined below are intended to serve only as guides to locate and temporarily correct minor faults. Causes of unsatisfactory performance should be investigated and corrected by your Volvo dealer only. See section "Road Assistance".

Engine fails to start or is difficult to start

The instructions for starting the engine have not been followed, see page 4:5.  
Start the engine according to the instructions.

Weak battery or dead cell.

With the starting (ignition) switch in the "Driving" or "On" position, check to see if the warning lights on the dashboard come on and if they stay on when the starter is engaged. If the lights do not come on or if they go off when the starter is engaged the battery is discharged, or see below.

Fault in the electrical/distributor ignition system

Check all the electrical connections to the starter motor and battery.



Clean or replace battery terminals if necessary.

The ground strap should also be checked for corrosion or looseness.

Check the spark plugs (gap should be 0.7 mm), clean or replace if necessary.

No fuel reaches the engine

Check that there is fuel in the tank.

Check that none of the hoses/connections in the fuel system are loose or kinked. Check that the fuel pump fuse (no. 2) is not blown.

Open circuit between starting (ignition) switch and starting (ignition) switch terminal on starter

The circuit is closed if a clicking sound is heard from the starter when it is engaged. If no clicking sound is heard, check that the blue wire at the starter is secure. If still no clicking sound is heard, the starting (ignition) switch or the wire is defective.

Blocked air cleaner/fuel filter

Replace filter(s).

Imbalance, resonance or heavy steering during driving

Wheel imbalance

Have the wheels re-balanced.

Insufficient oil in the power steering pump

Check the oil level, see page 8:12

Engine overheats

Radiator hoses cracked or leaking

Check the radiator hoses and replace if necessary.

Insufficient coolant

Check the coolant level and add as necessary. See page 8:16.

Fault in electric cooling fan

Check that the electric cooling fan functions properly.

**WARNING!** The electric cooling fan may start or continue to operate (for up to 6 minutes) after the engine has been switched off.

[pg. 6:17 Service diagnosis \(cont.\)](#)

Excessive fuel  
consumption

Spark plugs worn.  
Replace plugs.

Erratic idle  
(misfiring)

Intake system leaking.  
Check vacuum hose connections to manifold and idle air control valve.

Worn spark plugs.  
Remove. Clean or replace spark plugs.

Engine stops running at irregular  
intervals

Defective wires  
Check wire terminals at: fuel pump, coil, ignition switch and relays.

Intake system leaking  
Check vacuum hose connections at manifold and idle air control valve.

Fuel filter clogged  
Clean fuel tank filter and replace fuel line filter.

Misfiring at highway driving speed

Spark plugs fouled

Drive the vehicle in a lower gear and keep the engine rpm higher for a few miles in order to remove carbon deposit on the spark plugs. If this procedure is not effective, clean or replace the spark plugs. Please be aware that misfiring spark plugs can cause damage to the three-way catalytic converter.

Electrically operated sun roof cannot be closed

No current to sun roof motor

The overload circuit breaker (no. 37 in fuse box) has been activated.

Wait approx. 20 seconds for the circuit breaker to cool down. Check fuse no. 35.



Shiftlock release (automatic transmission only)

The gear selector is locked in the (P)ark position. To manually release the shiftlock:

- Turn the starting (ignition) key to position I
- Press firmly on the "SHIFTLOCK OVERRIDE" button located to the right of the base of the gear selector
- While holding the override button down, press the button on the front of the gear selector
- Move the gear selector from the ( P )ark position.

Fuel filler flap does not open

## Faulty motor in fuel filler flap

(Sedans):

Open the cover panel on the right tail light unit and pull on the hook. The filler flap can then be opened.

(Wagons):

Remove the right floor cover (the center storage compartment must be opened first) and the cover panel on the right lower tail light. Pull on the hook and the filler flap can then be opened.

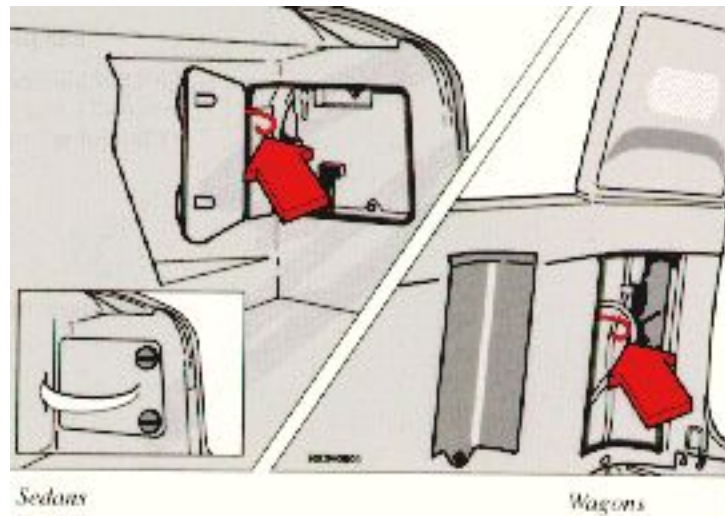

[Contents](#) | [Top of Page](#)

## Replacing bulbs

Make sure when installing bulbs, that the guide pin on the socket fits into its corresponding recess. When installing Halogen bulbs, do not touch the glass with your fingers since grease, oil or any other impurities can be carbonized onto the bulb and damage the reflector. Use bulbs of correct type and voltage. Failure to do so could cause the bulb failure warning light to activate.

NOTE: Turn the ignition and the light switch off before replacing any bulbs.

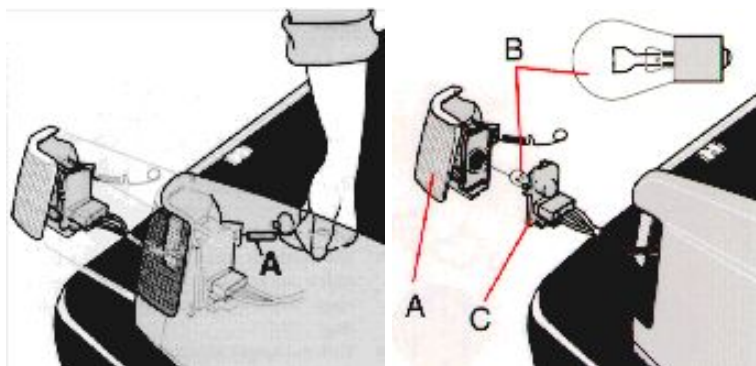

*A- Spring A- Lamp housing, B- Bulb 21/5W/24/2.2 cp BA 15 d, C- Bulb holder*

## Parking light/direction indicator

1. Loosen the spring which retains the lamp housing.
2. Withdraw the entire lamp housing; separate the bulb holder from the lamp unit.
3. Leave the connector with its wires in the bulb holder.
4. Remove the bulb from the holder by pressing in and turning counter-clockwise.
5. Insert a new bulb and reinstall the unit in the reverse order.

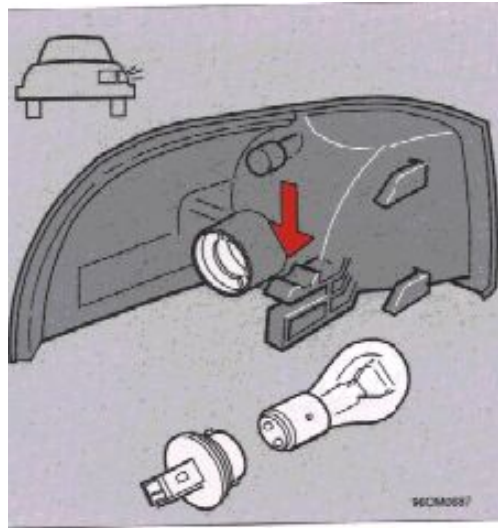

1 - Plastic cover, 2 - Bulb HB4/9006  
3 - Bulb HB3/9005, 4 - Connector

## Headlight bulb replacement

1. Turn the plastic cover counter-clockwise and remove it.
2. Turn the bulb and connector (one unit) 1/4 turn counter-clockwise and remove.
3. Disconnect the wiring from the bulb unit.
4. Connect a new bulb unit into the wiring without touching the bulb itself.
5. Re-insert the bulb into the headlight housing and turn 1/4 turn clockwise until the unit seats properly. The unit has three guide lugs to ensure proper seating.
6. Reinstall the plastic cover.

## Headlight adjustment

The height of the headlight beams can be adjusted according to vehicle load. The headlights should be re-aimed if heavy loads are carried in the trunk/cargo area or rear seat, or when towing a trailer.

To adjust the headlights:

- Park the car on a level surface and open the hood.
- The headlights are equipped with a level which can be seen by looking through the clear "window" on the top of the headlight lens.
- Turn the height adjustment knob (A) until the bubble in the level aligns with the "0" marks or within the dark marking lines.

Lateral headlight adjustment should only be carried out by an authorized Volvo dealer. The lateral adjustment scale (B) should be preset to "0".

[pg. 6:7 Replacing bulbs \(cont.\)](#)

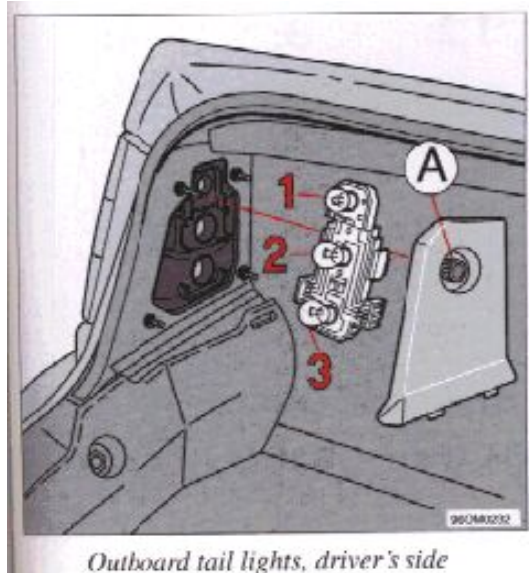

*Lamp location- right side, A- covers, B- bulb holder*

### Tail light bulbs (sedans)

1. Tail light
2. Direction indicator
3. Brake light
4. Tail light
5. Back-up light
6. Rear fog light (left side only)

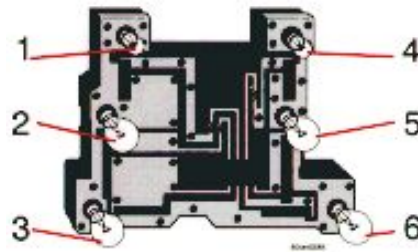

*Location of bulbs in holder*

All the bulbs in the tail light unit are replaced from inside the trunk as follows:

1. Turn the two plastic screws and open the cover over the rear lamp unit.
2. Loosen and remove the bulb holder.
3. Let the connector with its wires remain attached to the bulb holder.
4. Remove the bulb by pressing in and turning counter-clockwise.
5. Insert a new bulb into the holder and reinstall the holder into the tail light assembly.
6. Close the cover.

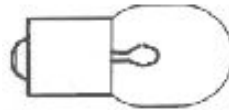

Bulbs 1, 4:  
5W/4 cp BA 15 s

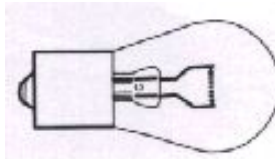

Bulbs 2, 3, 5, 6:  
21W/32 cp BA 15 s



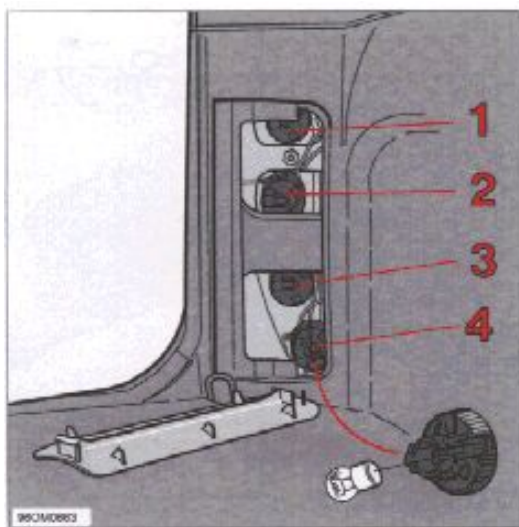

1,2,4

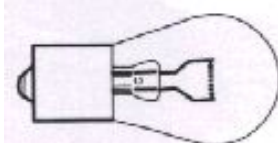

21W/32cp BA 15s

3,5

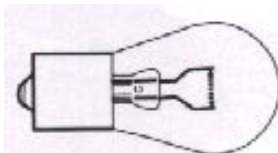

21/4W BAZ 15d

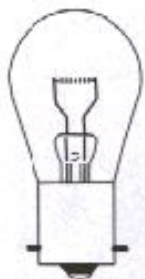

*Removing speaker from upper section*

Tail light bulbs (wagons)

1. Direction indicator
2. Brake light
3. Tail light
4. Back-up light
5. Tail light / Rear fog light (left side only)

All the bulbs in the tail light unit are replaced from inside the cargo space as follows:

- Turn the ignition key to position 0 and switch off the lights.
- Remove the upper panel of the tail light unit by using a screwdriver and/or the lower panel by first removing the side floor cover and then the panel.
- Press in the plastic catches (A or B) and take out the bulb holder.
- Remove the speaker (optional) from the upper section of the tail light unit.

- Leave the connector and cables connected to the bulb holder.
- Remove the bulb by pressing it inwards and turning it slightly counter-clockwise.
- Insert a new bulb into the bulb holder and reinstall the holder in the tail light assembly.
- Check that the bulb works. Reinstall the cover.

pg. 6:9 Replacing bulbs (cont.)

*Depress the catches (sedans)*



*Press sides and pull out/down (wagons)*

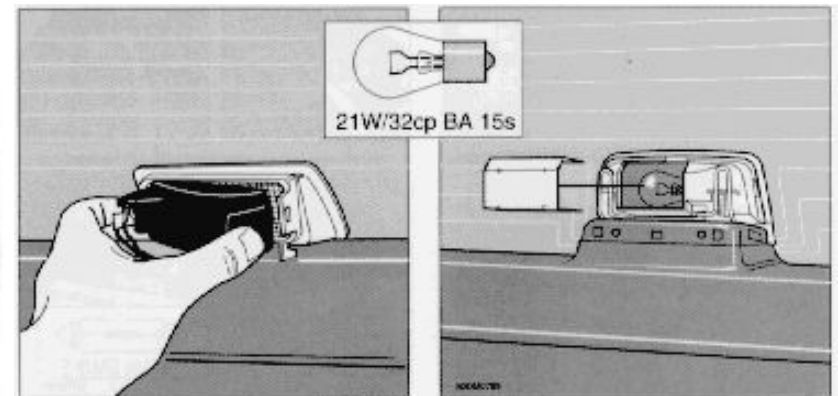

*Press in the springs (sedans) Remove the cover (wagons)*

### High-mounted brake light

*Sedans:*

- Turn off the ignition.
- Press in the springs on both sides of the holder.
- Pull the cover towards you.
- Depress the catches on both sides of the reflector and withdraw it from the holder.
- Replace the bulb.
- Reinstall the reflector.

- Press the cover into place.

Wagons:

- Turn off the ignition.
- Press the sides of the cover using both hands and pull it out and down.
- Remove the inner protective cover from the bulb.
- Remove the bulb by pressing in and turning slightly counter-clockwise.
- Replace the bulb.
- Reinstall the protective cover over the bulb.
- Press the cover into place.

[pg. 6:10 Replacing bulbs \(cont.\)](#)

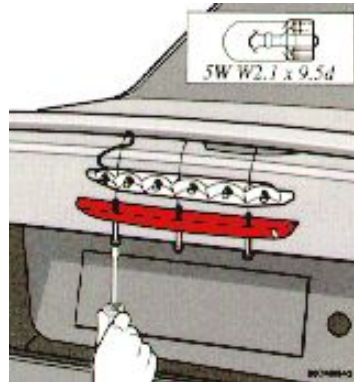

Brake lights mounted in spoiler (certain models)

- Switch off the lights.
- Unscrew the three screws.
- Insert the screwdriver and turn gently to loosen the glass lens to gain access to the bulb holder.
- Replace the bulb(s) and reinstall the bulb holder and glass lens.

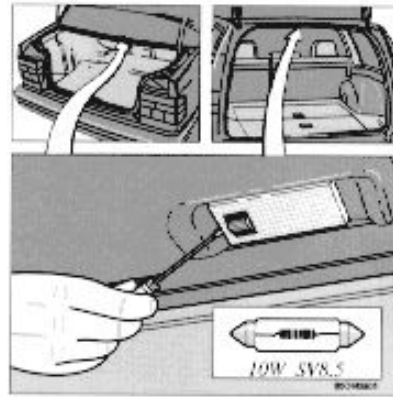

*Insert screwdriver and turn*

### Trunk light (sedans)/Rear courtesy light (wagons)

- Switch off the lights.
- Press in the catch with a screwdriver and remove the bulb holder.
- Replace the bulb and reinstall the bulb holder.

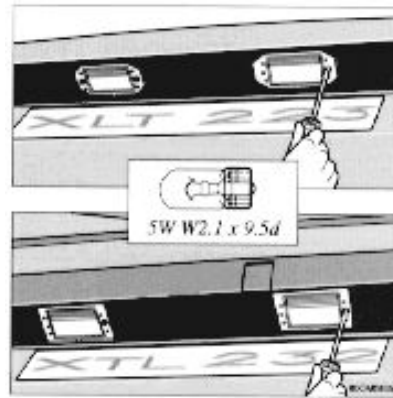

*Phillips-head screwdriver for glass lens*

### License plate lights (sedans and wagons)

- Switch off the lights.
- Unscrew the two screws.

- Insert the screwdriver and turn gently to loosen the glass lens.
- Replace the bulb and reinstall the glass lens.

pg. 6:11 Replacing bulbs (cont.)

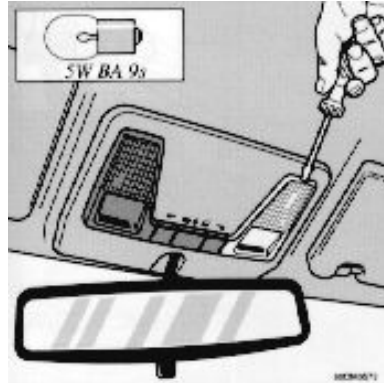

*Insert screwdriver, turn and pull downward*

#### Front courtesy lights

- Switch off the ignition.
- Insert a screwdriver and turn carefully to loosen the glass lens.
- Replace the bulb and press the glass lens back into place.

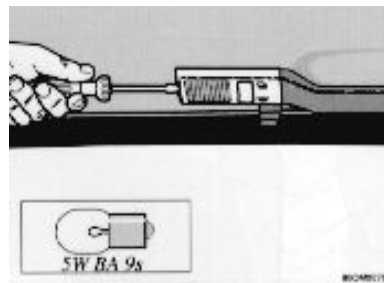

*Insert a screwdriver and turn*

#### Rear reading lights

- Switch off the ignition.
- Insert a screwdriver and turn to loosen the lamp unit.
- Replace the bulb and press the lamp unit back into place.

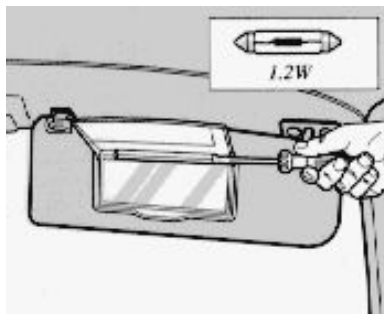

*Insert a screwdriver and turn*

#### Vanity mirror

- Switch off the ignition.
- Insert a screwdriver under the lower edge and turn to loosen the glass lens.
- Push out the bulb and replace it.
- Press the lower edge of the lens into place above the four catches.
- Press the upper edge of the lens into place.

[pg. 6:12 Replacing bulbs \(cont.\)](#)

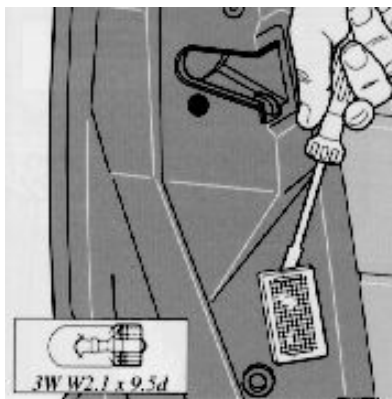

## Door warning lights

### Front

- Slide the lamp unit upward and lift it out.
- Twist off the bulb holder.
- Pull the bulb straight out.
- Replace the bulb.
- Reinstall the holder and lamp unit in reverse order.

### Rear

- Insert a screwdriver and turn carefully to loosen the glass lens.
- Pull the bulb straight out.
- Replace the bulb.
- Press the lens back into place.

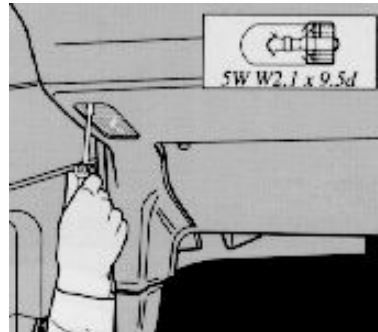

## Door step courtesy lights

- Insert a screwdriver and turn carefully to loosen the glass lens.
- Withdraw the lamp unit, bend back the tabs and remove the plate.
- Replace the bulb.
- Reinstall the plate.
- Press the lamp unit back into place.

NOTE: Other bulbs may be difficult for the owner to replace. Let your Volvo dealer replace these bulbs if necessary.

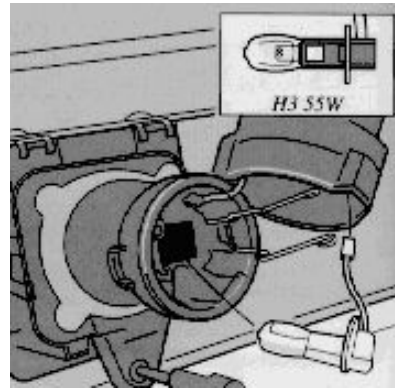

*Front fog lights in spoiler*

### Front fog lights (option)

- Switch off the lights.
- Turn the plastic cover counter-clockwise to remove it.
- Press the spring toward the lamp unit to release it and move it to the side.
- Replace the bulb.
- Reinstall in reverse order.



[Contents](#) | [Top of Page](#)



## Car care

[pg. 7:1 Car care](#)

### Car care

Car care includes not only maintaining the appearance of the car, but also protecting the car exterior from the effects of air pollution, rain, mud or road salt. The rustproofing compound under the car should be checked regularly and, if necessary, damaged areas should be repaired. The paintwork should also be touched up immediately, if damaged, to prevent rust formation.

[7:2 Rustproofing](#)

[7:4 Paint touch-up](#)

[7:6 Washing](#)

[7:7 Automatic car washing, Polishing and waxing](#)

[7:8 Cleaning the upholstery](#)

[pg. 7:2 Rustproofing](#)

### What causes rust

The two most common causes of rust to your car are:

- The accumulation of road dirt and moisture in hard-to-get-at cavities and other areas under the car.
- The removal of paint and protective coatings on the outside of the car and underneath through damage by stones, gravel or minor accidents.

Several factors influence the speed at which corrosion will occur:

- The length of time various parts of the car stay wet. Parts of the car filled with road dirt and water remain damp for long periods of time even after other parts have dried. Particular attention should be paid to the underside of the car and floor sections inside. The floor sections stay wet because moisture collects and remains under the floor matting. Drain holes located at the bottom of the doors can get clogged with dirt, trapping water inside the door and causing the door to rust through at the bottom.

- Corrosion will be accelerated in areas of higher relative humidity, especially where temperatures often stay above the freezing point and where the atmosphere is affected by industrial pollution, or where salt is used for de-icing the roads. Where parts of the car are covered with road dirt containing road salt, corrosion will be accelerated at lower relative humidity than if the surface were clean.
- Increased temperature will cause an accelerated rate of corrosion of those parts of the car which are not well ventilated to permit quick drying.
- Industrial pollution and the presence of salt will also accelerate the deterioration of paint finishes.

The foregoing identifies the need for every car owner to keep his or her car particularly the underside as clean and dry as possible and to repair any minor damage to paintwork and protective coating as soon as possible.

The need is more important in those areas where road salt is used for de-icing, the relative humidity is higher, air pollution is present, and temperatures regularly stay above freezing.

### Rustproofing, inspection and touching-up

Your Volvo was carefully and thoroughly rustproofed at the factory. The underbody and wheelhousings were sprayed with a thick, durable rustproofing compound and the beams, internal cavities and end sections were sprayed with a low viscous, penetrating rustproofing agent. There are two very effective methods of maintaining this protection:

- Keep your car clean. Clean the underbody, wheelhousings and the edges of the fenders using water at high pressure.
- Inspect and touch-up the rustproofing if necessary.

### The invisible (internal) rustproofing

As part of your maintenance schedule, it is important that the invisible rustproofing (used for beams, internal cavities and end sections) be retreated first after 36 months and, thereafter, every 24 months. Bear in mind, if good results are to be obtained, that these sections must be treated with a fine spray of Volvo-approved rustproofing compound by your authorized Volvo dealer.

Most of the sheet metal body sections on your Volvo are galvanized, which provides much more protection against corrosion. There are many imitations of Genuine Volvo sheet metal body sections on the market.

If any body sections on your car need to be replaced because of an accident or other damage, request

only Genuine Volvo sheet metal body sections at the time of the estimate and before your car is repaired.

pg. 7:3 Rustproofing (cont.)

### The visible rustproofing

The visible (external) rustproofing must be inspected by an authorized Volvo dealer at 20,000 mile (32,000 km) intervals. If it is necessary to touch-up the rustproofing, this should be done immediately to prevent moisture penetration. Wash and dry the car thoroughly before touching up. Use spray-on or brush-on rustproofing compounds. An oil can with a long flexible spout may be used for parts which are difficult to reach.

There are three different types of rustproofing compounds available:

A ) thin (ML), for seams under the car.

B ) thin (transparent) for visible parts.

C ) thick, for parts on the underbody and wheel housing which experience most wear.

Parts of the car which may need to be touched up (and the recommended rustproofing compound) are:

- visible welded seams and panel seams-(thin)
- underbody and wheel housing-(thick)
- door hinges-(thin)
- hood hinges and locks-(thin)

After completion of all work on the vehicle, remove excess rustproofing compound with a cloth soaked in kerosene. The sheet metal surfaces of the engine compartment are protected by a transparent wax-based rustproofing compound. The compound withstands normal washings without deterioration. Mineral based solvents will, however, dissolve the compound, especially so if they contain emulsifiers. In such cases the wax protection should be renewed.

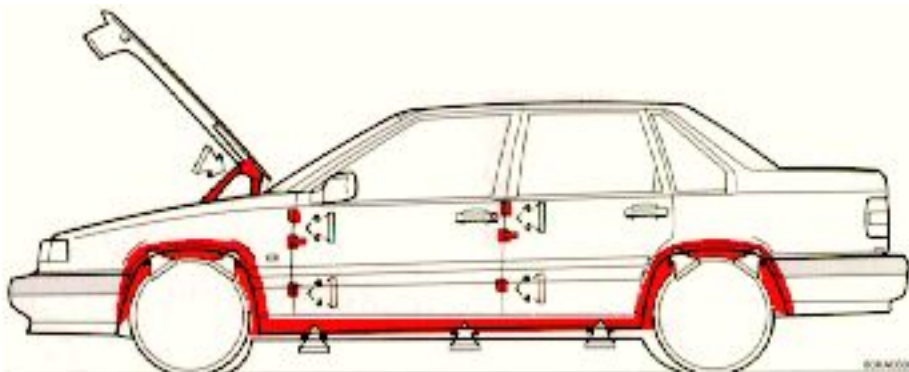

## Paint touch-up

Paint damage requires immediate attention to avoid rusting. Make it a habit to check the finish regularly - when washing the car for instance. Touch up if necessary.

Paint repairs require special equipment and skill. Contact your Volvo dealer for any extensive damage.

Minor scratches can be repaired by using Volvo touch-up paint.

**NOTE:** When ordering touch-up paint from your Volvo dealer, use the paint code indicated on the model plate. The plate is located on the panel above the right-side head lights.

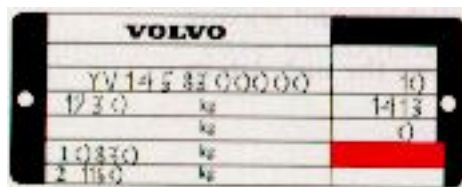

## Minor stone chips and scratches

### Material:

Primer - can

Paint - spray can or touch-up bottle

Brush

Masking tape

**NOTE:** When touching up the car, it should be clean and dry. The surface temperature should be above 60° F (15° C).

## Scars on the surface

If the stone chip has not penetrated down to the metal and undamaged layer of paint remains, the touch-up paint can be applied as soon as the spot has been cleaned.

## Deep scars

1. Place a strip of masking tape over the damaged surface. Pull the tape off so that any loose flakes of paint adhere to it.

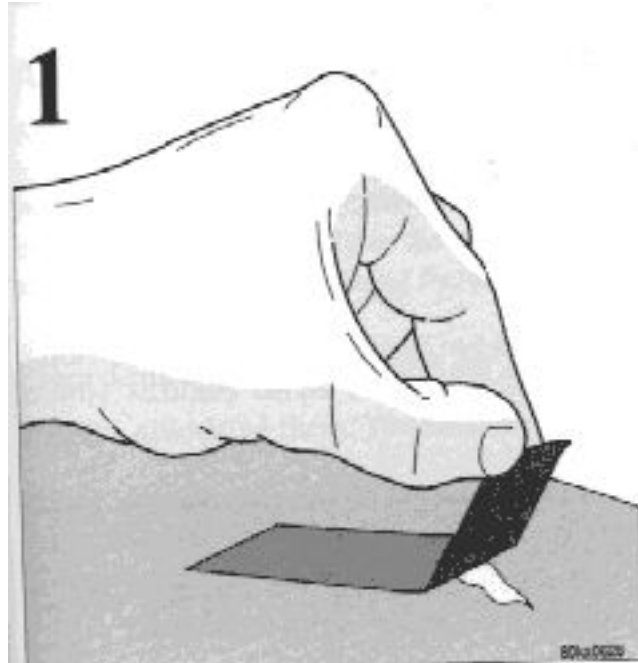

2. Thoroughly mix the primer and apply it with a small brush.

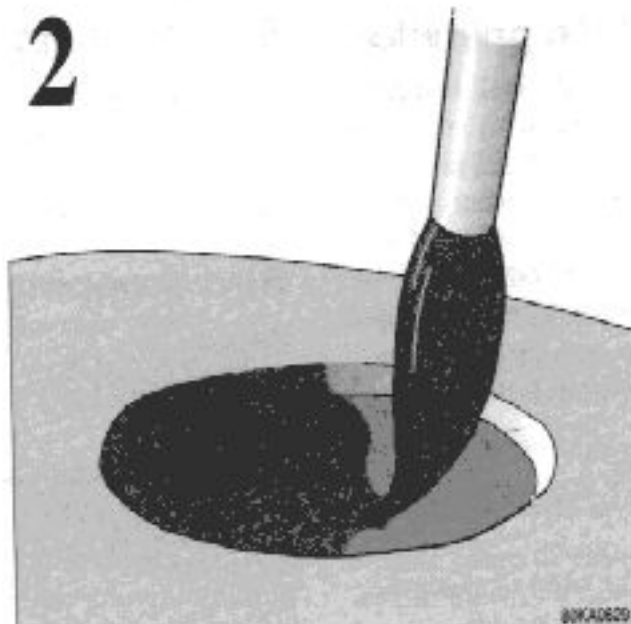

When the primer surface is dry, the paint can be applied using a brush. Mix the paint thoroughly; apply several thin paint coats and let dry after each application.

[pg. 7:5 Paint touch-up \(cont.\)](#)

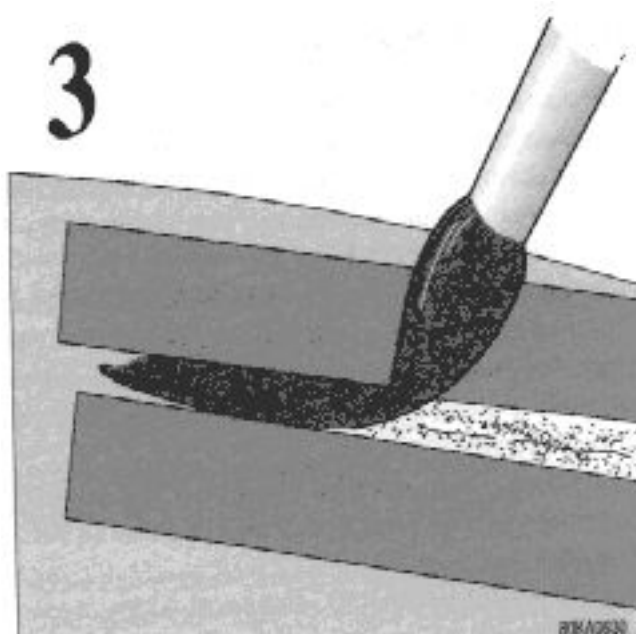

3 If there is a longer scratch, you may want to protect surrounding paint by masking it off.

Touching up damaged paint on fender edges and sills

**Material:**

Primer - spray can

Paint - spray can

Masking tape

**Note:** When touching up the car, it should be well cleaned and dry and have a temperature exceeding 60° F (+15°C).

When large surfaces have to be repainted, suitably mask the surrounding area with masking tape and paper.

Remove this masking as soon as the final coat has been sprayed on, before the paint dries.

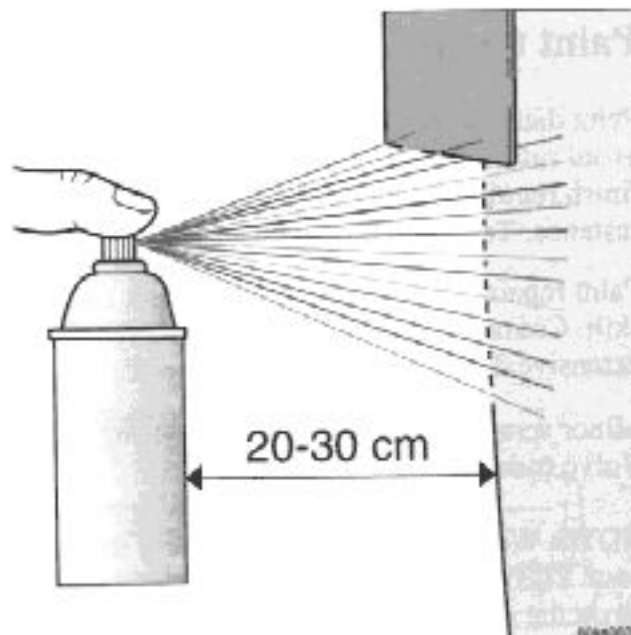

1 Remove loose flakes of paint with masking tape.

2 Move the spray can slowly and regularly from side to side, about 8-12 inches (20-30 cm) from the surface.

3 When the primer has dried apply the surface enamel in the same way. Spray on several times and allow the paint to dry a minute or so between each application.

**WARNING!**

Spray painting should be done in a well-ventilated and dust-free area.

NOTE: Legislation in your area may prohibit the purchase or use of spray paint. Please check your local regulations.

## pg. 7:6 Washing

### Washing the car

- The car should be washed at regular intervals since dirt, dust, insects and tar spots adhere to the paint and may cause damage.

NOTE: It is particularly important to wash the car frequently in the wintertime to prevent corrosion, when salt has been used on the roads.

- When washing the car, do not expose it to direct sunlight. Use lukewarm water to soften the dirt before you wash with a sponge, and plenty of water, to avoid scratching.
- A detergent can be used to facilitate the softening of dirt and oil.
- A water-soluble grease solvent may be used in cases of sticky dirt. However, use a washplace equipped with a drainage separator.
- Dry the car with a clean chamois and remember to clean the drain holes in the doors and rocker panels.
- The power radio antenna (sedans) must be dried after washing.
- Tar spots can be removed with kerosene or tar remover after the car has been washed.
- A stiff-bristle brush and lukewarm soapy water can be used to clean the wiper blades. Frequent cleaning improves visibility considerably.
- Wash off the dirt from the underside (wheel housings fenders, etc.).
- In areas of high industrial fallout, more frequent washing is recommended.

**CAUTION:** During high pressure washing the spray mouthpiece must never be closer to the vehicle than 13" (30 cm). Do not spray into the locks.

- When washing or steam cleaning the engine, avoid spraying water or steam directly on the distributor or other electrical components or toward the rear side of the engine.
- After cleaning the engine, the spark plug wells should be inspected for water and blown dry if necessary.



## Suitable detergents

Special car washing detergents or liquid dishwashing detergent can be used. A suitable mixture is about 2.5 fl. oz. (8.5 cl) of detergent to 2.6 US gal. (10 liters) of warm water. After washing with a detergent the car should be well rinsed with clean water.

## Bird droppings

Remove from paintwork as soon as possible. Otherwise the finish may be permanently damaged.

### WARNING!

- When the car is driven immediately after being washed, apply the brake several times in order to remove any moisture from the brake linings.
- Engine cleaning agents should not be used when the engine is warm. This constitutes a fire risk.

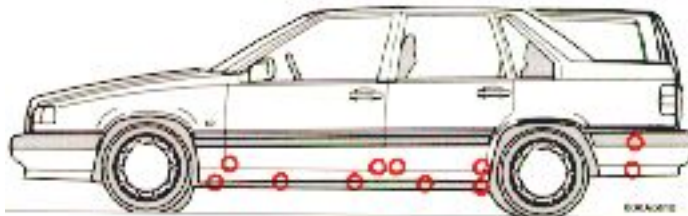

NOTE: When washing the car, remember to remove dirt from the drain holes in the doors and sills.  
Bumpers: Wash the bumpers with the same cleaning agent used on the rest of the car. Never clean the bumpers with gasoline or paint thinner. Difficult spots can be removed with denatured alcohol. To avoid scratches, do not dry the bumpers with paper.

[pg. 7:7 Automatic car washing, Polishing and waxing](#)

## Automatic washing - simple and quick

An automatic wash is a simple and quick way to clean your car, but it is worth remembering that it may not be as thorough as when you yourself go over the car with sponge and water. Keeping the underbody

clean is most important, especially in the winter. Some automatic washers do not have facilities for washing the underbody.

Before driving into an automatic wash, make sure that the side view mirrors, auxiliary lamps, etc., are secure, otherwise there is risk of the machine dislodging them. You should also lower the antenna (sedans).

We do NOT recommend washing your car in an automatic wash during the first six months (because the paint will not have hardened sufficiently).

### Polishing and waxing

Normally, polishing is not required during the first year after delivery, however, waxing may be beneficial.

Before applying polish or wax the car must be washed and dried. Tar spots can be removed with kerosene or tar remover. Difficult spots may require a fine rubbing compound.

After polishing use liquid or paste wax.

Several commercially available products contain both polish and wax.

Waxing alone does not substitute for polishing of a dull surface.

A wide range of polymer-based car waxes can be purchased today. The waxes are easy to use and produce a long-lasting, high-gloss finish that protects the bodywork against oxidation, road dirt and fading.

[pg. 7:8 Cleaning the upholstery](#)

### Cleaning the upholstery

The fabric can be cleaned with soapy water or a detergent. For more difficult spots caused by oil, ice cream, shoe polish, grease, etc., use a clothing/clothing fabric stain remover.

The plastic in the upholstery can be cleaned with a soft cloth and mild soap solution.

Leather upholstery can be cleaned with a soft cloth and mild soap solution. For more different spots, Volvo offers a leather care kit.

On no account must gasoline, naphtha or similar cleaning agents be used on the plastic or the leather since these can cause damage.

### Cleaning the seat belts

Clean only with lukewarm water and mild soap solution.

### Cleaning floor mats

The floor mats should be vacuumed or brushed clean regularly, especially during winter when they should be taken out for drying. Spots on textile mats can be removed with a mild detergent.

### Bear in mind

- Take extra care when removing stains such as ink or lipstick since the coloring can spread.
- Use solvents sparingly. Too much solvent can damage the seat padding.
- Start from the outside of the stain and work toward the center.



[Contents](#) | [Top of Page](#)

## Service and routine maintenance

[pg. 8:1 Volvo Service](#)

### Service - an investment

An investment which will pay dividends in the form of improved reliability, durability, and resale value.

[8:2](#) Label information

[8:3](#) Maintenance service, Warranty

[8:4](#) Maintenance schedule

[8:6](#) Servicing

[8:9](#) Lubrication

[8:10](#) Engine oil

[8:12](#) Power steering fluid, Brake/clutch system fluid reservoir

[8:13](#) Automatic transmission fluid

[8:14](#) Drive belt

[8:15](#) Windshield washer nozzle, Washer fluid reservoir

[8:16](#) Coolant

[8:17](#) Engine compartment

[pg. 8:2 Label information](#)

### 1 Vehicle Emission Control Information

Your Volvo is designed to meet all applicable emission standards, as evidenced by the certification label on the underside of the hood. For further information regarding these regulations, please consult your Volvo dealer.

### 2 Vacuum hose routing

### 3 Loads and Tire Pressures

### 4 Model plate

Vehicle Identification Number (VIN). Codes for color and upholstery etc. This plate is located on panel above the right headlight.

### 5 Vehicle Identification Number (VIN) \*

The VIN plate is located on the top left surface of the dashboard. The VIN is also stamped on the right hand door pillar.

### 6 Federal Motor Vehicle Safety Standards (FMVSS) specifications (USA) and Ministry of Transport (CMVSS) Standards (Canada)

Your Volvo is designed to meet all applicable safety standards, as evidenced by the certification label on the facing side of the driver's door. For further information regarding these regulations, please consult your Volvo dealer.

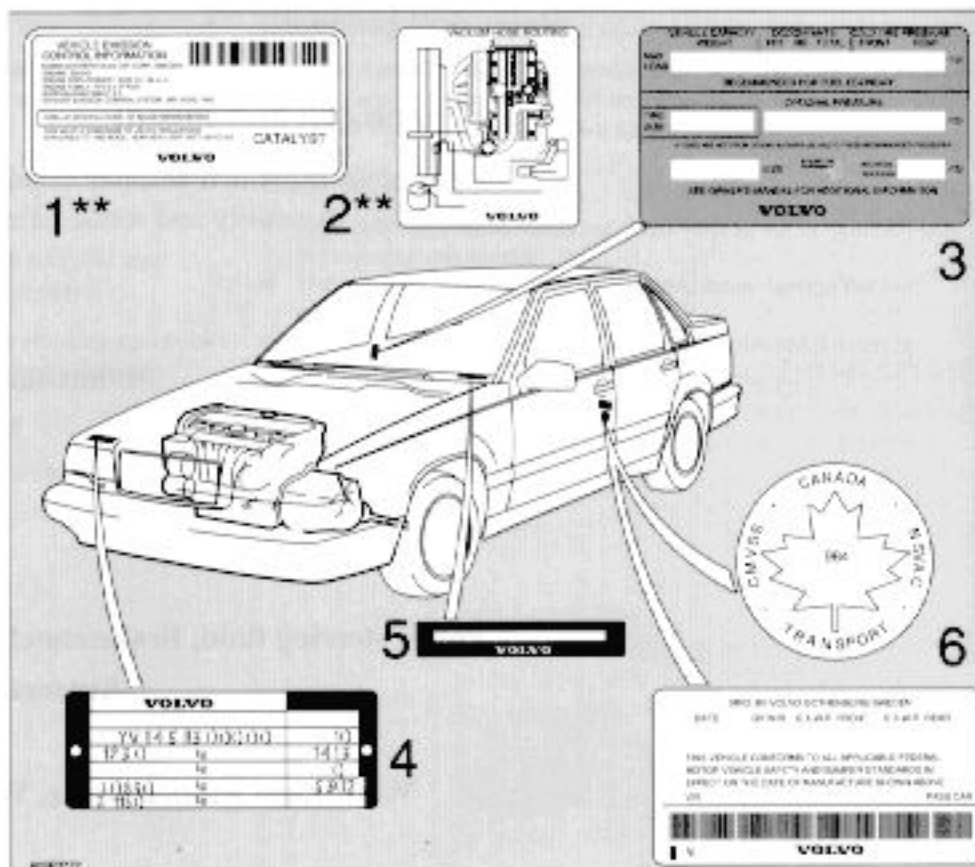

\* The Vehicle Identification Number (VIN) should always be quoted in all correspondence concerning your vehicle with the retailer and when ordering parts.

\*\* These decals are located on the underside of the hood.

All specifications are subject to change without notice.

[pg. 8:3 Maintenance service, Warranty](#)

Maintenance service at 10,000 miles \* (16,000 km) intervals

Volvo advises you to follow the service program at 10,000 miles\* (16,000 km) intervals which is outlined in the "Maintenance Records Manual". This maintenance program contains inspections and services necessary for the proper function of your car over the next 10,000 miles\* (16,000 km). The maintenance services contain several checks which require special instruments and tools and therefore must be performed by a qualified technician. To keep your Volvo in top condition, specify time tested and proven Genuine Volvo Parts and Accessories.

The Federal Clean Air Act - U.S.

The Clean Air Act requires vehicle manufacturers to furnish written instructions to the ultimate purchaser to assure the proper functioning of those components that control emissions. The maintenance instructions listed in the "Servicing" section of this Manual represent the minimum maintenance required. These services are not covered by the warranty. You will be required to pay for labor and material used. Refer to your Warranty booklet for further details.

\* Turbo models: 5,000 miles (8,000 km)

Maintenance services

Your Volvo has passed several major inspections before being delivered to you, according to Volvo specifications. The maintenance services outlined in this book should be performed every 10,000 miles\* (16,000 km). The extended maintenance service intervals make it even more advisable to follow this program. Inspection and service should also be performed any time a malfunction is observed or suspected. It is recommended that receipts for vehicle emission services be retained in the event that questions arise concerning maintenance. See your "Maintenance Records Manual".

Applicable warranties - U.S.

In accordance with U.S. Federal Regulations, the following list of applicable U.S. warranties is provided. For Canadian specification vehicles, see your separate warranty booklet.

- New Car Limited Warranty
- Parts and Accessories Limited Warranty
- Corrosion Protection Limited Warranty
- Seatbelt and Supplemental Restraint Systems Limited Warranty
- Emission Design and Defect Warranty
- Emission Performance Warranty

These are the Federal warranties; other warranties are provided as required by state law. Refer to your separate Warranty booklet for detailed information concerning each of the warranties.

[pg. 8:4 Servicing](#)

## Maintenance schedule

A = Adjust (Correct if necessary) I = Inspect (Correct or Replace if necessary)

R = Replace L = Lubricate

Maintenance Operation thousand miles (thousand km)	5 <sup>3</sup> (8)	10 (16)	15 <sup>3</sup> (25)	20 (32)	25 <sup>3</sup> (40)	30 (48)	35 <sup>3</sup> (56)	40 (64)	45 <sup>3</sup> (72)	50 (80)	55 <sup>3</sup> (88)	60 <sup>2</sup> (96)
<b>EMISSION SYSTEM MAINTENANCE</b>												
Engine oil and filter <sup>1</sup>	R <sup>3</sup>	R	R <sup>3</sup>	R	R <sup>3</sup>	R	R <sup>3</sup>	R	R <sup>3</sup>	R	R <sup>3</sup>	R
Engine drive belt (accessory belt)												R
Air cleaner filter						R						R
Spark plugs						R						R
Automatic transmission fluid		I		I		I		I		I		I
Timing belt - B 5254 S, B5234 T <sup>4</sup>												
Exhaust pipe attachment to turbo-charger, retorque, B 5234 T	A <sup>3</sup>											

NOTE: The oil should be changed at these intervals or after 750 hours of driving or after 12 months

which ever occurs first. See "Service Reminder indicator", page 1:5.

2) For services beyond 60,000 miles (96,000 km), consult your "Maintenance Records booklet".

3) These services apply to turbo models only.

4) For proper functioning of the vehicle and its emission control system, Volvo recommends that the timing belt be replaced every 70,000 miles (112,000 km).

[pg. 8:5 Servicing \(cont.\)](#)

## Maintenance schedule

A = Adjust (Correct if necessary) I = Inspect (Correct or Replace if necessary)

R = Replace L = Lubricate

Maintenance Operation thousand miles (thousand km)	10 (16)	20 (32)	30 (48)	40 (64)	50 (80)	60 (96)
<b>ENGINE SYSTEM MAINTENANCE</b>						
<b>ENGINE</b>						
Fuel line filter <sup>1</sup>						
PCV Nipple (orifice)/hoses,clean						I
Battery	I	I	I	I	I	I
EGR valve, clean <sup>2</sup>						
<b>BRAKES</b>						
Inspect brakes, replace components as necessary	I	I	I	I	I	I
Brake Fluid <sup>3</sup>						
<b>STEERING/SUSPENSION</b>						
Rotate tires/check wear (align front end if needed)	I	I	I	I	I	I
Check power steering fluid level.	I	I	I	I	I	I
Grease front link arm stops	L	L	L	L	L	L
<b>BODY</b>						
Power antenna (clean)	I	I	I	I	I	I
Trunk/hood, hinges and latches	L	L	L	L	L	L



- 1) Replace at 100,000 miles (160,000 km)
- 2) Clean at 100,000 miles (160,000 km)
- 2) Brake fluid should be changed at owner request every second year (once a year if the car is driven in mountainous areas or in areas with high humidity).

The following items should be checked weekly by the driver (it takes only a few minutes).

Engine oil level Horns

Brake fluid level Windshield wipers

Radiator coolant level Tire pressure (all five tires)

Operation of all lights Level of windshield washer fluid

The following should also be carried out at regular intervals:

Washing

Polishing

Cleaning

Rust protection



[Contents](#) | [Top of Page](#)

pg. 8:12 Power steering fluid, Brake/clutch fluid reservoir

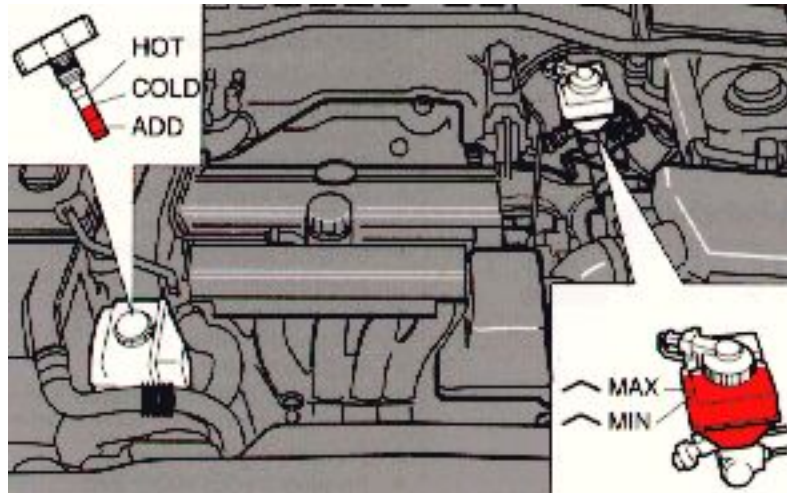

### Power steering fluid

The dipstick has marks for checking hot and cold oil. The oil level when the engine is cold must never be higher than the COLD mark. After the engine has reached normal operating temperature, the level may not be higher than the HOT mark. Top up when the level is at the ADD mark. Check the level at every service.

Fluid type: ATF

Replace: No fluid change required.

### Brake and clutch systems

The brake and clutch systems share the same fluid reservoir. The fluid level should be between the MIN and MAX marks.

Fluid type: DOT 4+

Replace\*: Every second year or 30,000 miles (48,000 km). The fluid should be replaced once a year or every 15,000 miles (24,000 km) when driving under extremely hard conditions (mountain driving, etc.)

Check, without removing the cap, that the level is above the " MIN " mark of the fluid reservoir. Always entrust brake/clutch fluid changing to an authorized Volvo dealer.

\* At owner request

pg. 8:13 Automatic transmission fluid

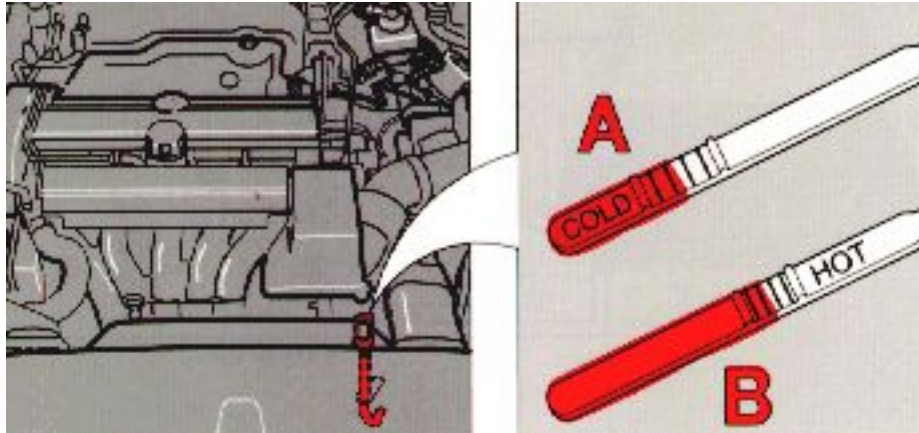

Check the oil level as follows:

Park the car on a level surface with the engine idling . Slowly move the gear selector lever through all the shift positions and then to position P. Wait 3 minutes before checking the oil level.

As the illustration shows, the dipstick has a COLD and a HOT side. The oil level should be between the MIN and MAX marks. Wipe the dipstick with a clean cloth.

**WARNING!** The oil may be very hot.

Do not use rags that could leave lint on the dipstick. The transmission is topped up via the dipstick tube. The space between the MIN and MAX marks on the dipstick corresponds to 0.5 US qt. (0.5 liter). Do not fill the transmission with too much oil, since this can result in oil being ejected from the transmission. Too little oil, on the other hand, can negatively affect transmission operation, particularly in very cold weather.

**A Cold transmission:** oil temperature 105° F (40° C). This is a normal temperature for the transmission after idling for about 10 minutes. At oil temperatures below 105° F (40° C), the level may be below the MIN mark.

**B Warm transmission:** oil temperature 169° F (80° C). This temperature is reached after driving for

about 30 minutes. At oil temperatures above 190° F (90° C), the level may be above the MAX mark.

Fluid type: ATF Dexron IIE or Mercon.

**WARNING!** Oil spilled on a hot exhaust pipe constitutes a fire risk.

[pg. 8:14 Drive belt](#)

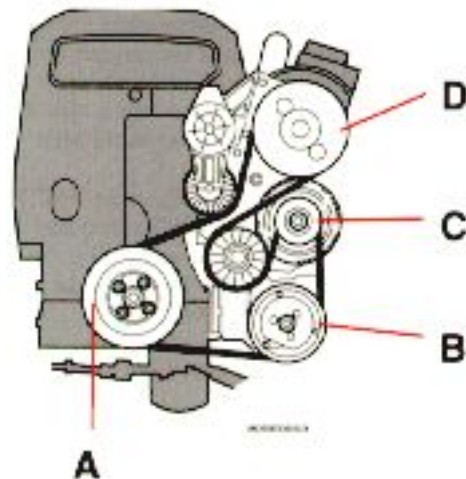

*A - crankshaft, B - A/C compressor,  
C - generator, D - power steering pump*

### Belt check

Check the belt regularly to make sure it is in good condition and is clean. A worn or dirty belt can cause poor cooling and low generator output as well as impair the operation of the power steering and the air conditioning unit.

**NOTE :** The belt on the 850 is equipped with a self-tensioning mechanism and requires no adjustment between changes.

**WARNING!** The engine must not be running when this check is performed.

pg. 8:15 Windshield washer nozzles, Washer fluid reservoir



### Adjusting washer nozzles

The washer jets should spray the windshield as shown above. Use the edge of a small screwdriver to adjust the nozzles if necessary.

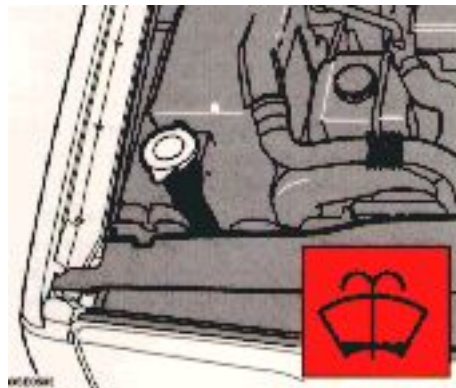

### Washer fluid reservoir

The washer fluid reservoir is located in the engine compartment and holds approx. 3.2 US qts. (3.0 liters).

During cold weather, the reservoir should be filled with windshield washer solvent containing anti-freeze.

pg. 8:16 Coolant

## Check coolant level

The cooling system must be filled with coolant and not leak to operate at maximum efficiency. Check the coolant level regularly. The level should be between the "MAX" and "MIN" marks on the expansion tank. The check should be made with particular thoroughness when the engine is new or when the cooling system has been drained.

Do not remove the filler cap other than for topping up with coolant. Frequent removal may prevent coolant circulation between the engine and the expansion tank during engine warm up and cooling.

## Changing coolant

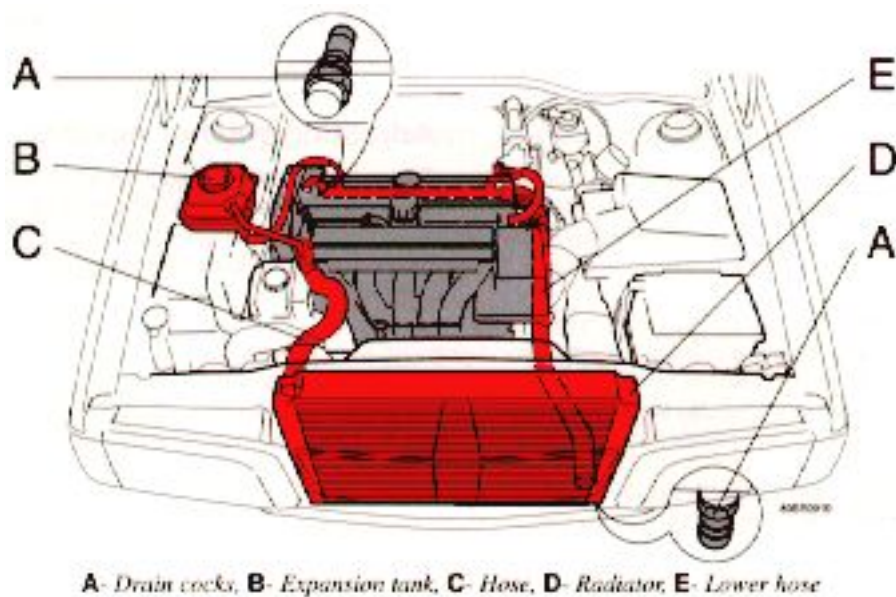

Normally, the coolant does not need to be changed. If the system must be drained, use the following procedure:

- 1 Remove the expansion tank cap.
- 2 Move the temperature adjustment control to max. heat. Open the drain cocks at the rear left of the engine block and at the bottom right corner of the radiator.
- 3 Disconnect the lower right radiator hose.

Filling:

- 4 Close the drain cocks and reconnect the hose.
- 5 Fill the expansion tank to the MAX mark or slightly above.
- 6 Run the engine until hot. Check the cooling system connections for tightness. Recheck the coolant level.

Capacity: Approx. 7.6 US qts. (7.2 liters)

Turbo - 7.4 US qts. (7.0 liters)

Coolant: Volvo Genuine Coolant/Antifreeze only.

NOTE: Do not top up with water only. Water by itself reduces the rust-protective and anti-freeze qualities of the coolant and has a lower boiling point. It can also cause damage to the cooling system if it should freeze.

**WARNING:** If the engine is warm and you are going to top up coolant, unscrew the tank cap slowly in order to allow any excess pressure to escape.

**CAUTION:** The cooling system must always be kept filled to the correct level. If it is not kept filled, there can be high local temperatures in the engine which could result in damage. Different types of anti-freeze/coolant may not be mixed.

[pg. 8:17 Engine compartment](#)

Engine compartment 850  
(engine B 5254 S / B 5252 S)

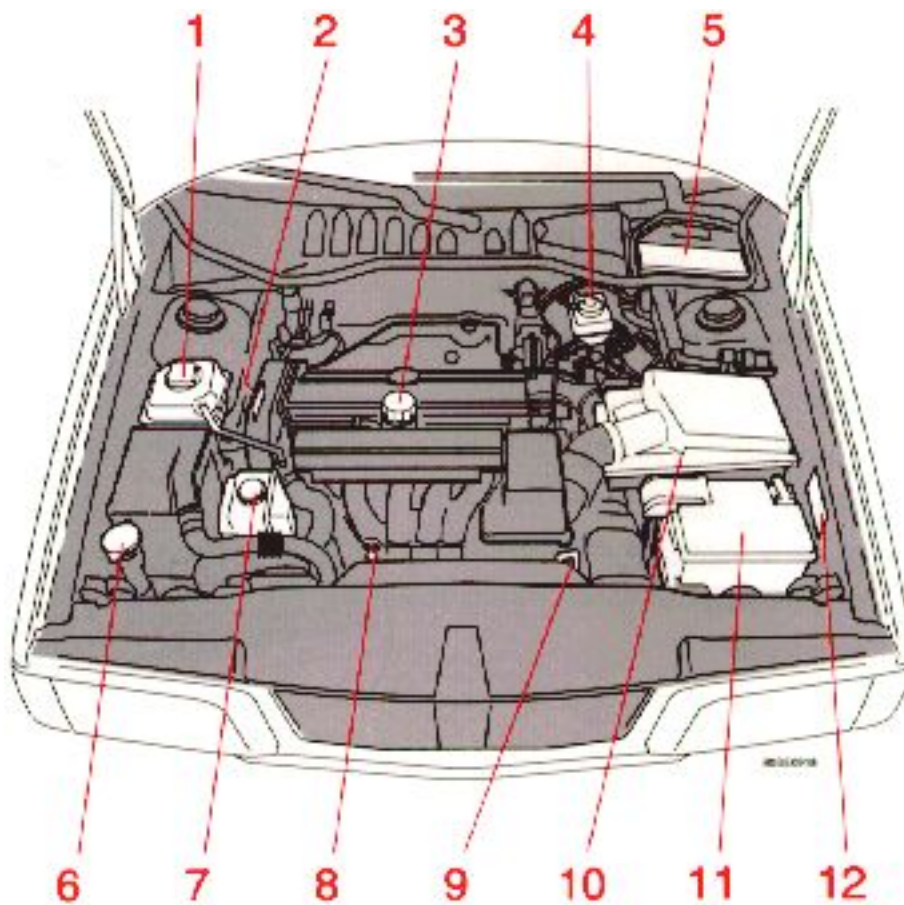

- 1 Expansion tank, coolant
- 2 Engine designation plate
- 3 Oil filler cap, engine
- 4 Clutch/brake system fluid reservoir
- 5 Fuse box
- 6 Washer fluid reservoir
- 7 Power steering fluid reservoir
- 8 Dipstick - engine oil
- 9 Dipstick - automatic transmission
- 10 Air cleaner
- 11 Battery
- 12 Data plate

**WARNING!** The cooling fan may start or continue to operate (for up to 6 minutes) after the engine has been switched off.

[pg. 8:18 Engine compartment \(cont.\)](#)



(engine B 5234 T)

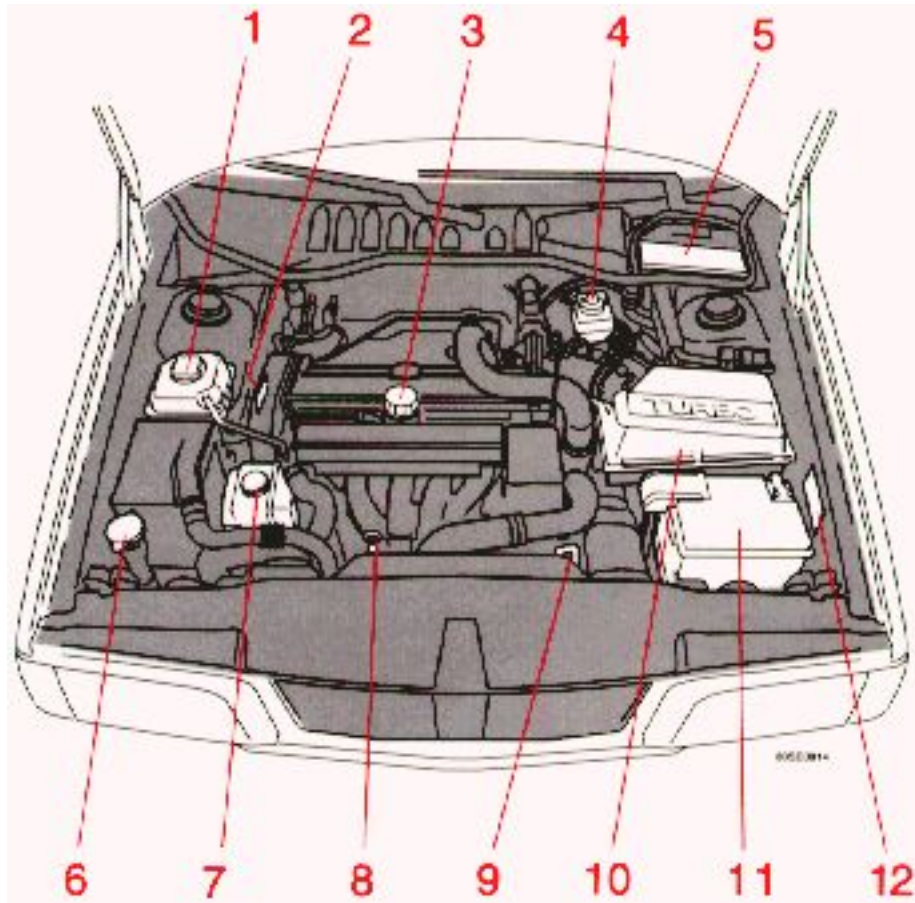

- 1 Expansion tank, coolant
- 2 Engine designation plate
- 3 Oil filler cap, engine
- 4 Clutch/brake system fluid reservoir
- 5 Fuse box
- 6 Washer fluid reservoir
- 7 Power steering fluid reservoir
- 8 Dipstick - engine oil
- 9 Dipstick - automatic transmission
- 10 Air cleaner
- 11 Battery
- 12 Data plate

**WARNING!** The cooling fan may start or continue to operate (for up to 6 minutes) after the engine has been switched off.



[Contents](#) | [Top of Page](#)

## pg. 8:6 Servicing (cont.)

The following precautions must be observed when carrying out repairs to the vehicle

**WARNING!** The distributor ignition system operates at very high voltages. Special safety precautions must be followed to prevent injury. Always turn the ignition off when:

- Connecting engine test and diagnostic equipment to the vehicle (timing light, tach-dwell tester, ignition oscilloscope, etc.).
- Replacing distributor ignition components e.g. plugs, coil, etc.
- Do not touch any part of the distributor ignition system while the engine is running. This may result in unintended movements and body injury.

### Battery

- Check that the battery cables are correctly connected and properly tightened.
- Never disconnect the battery when the engine is running, for example when changing the battery.
- The battery should be disconnected when a boost charger is used.
- Switch off the radio before disconnecting the battery. If your radio has an anti-theft code and the battery is disconnected, the radio code has to be re-entered in order for the radio to function.

### Replacing spark plugs

The spark plugs should be changed every 30,000 miles (48,000 km). However, city driving or fast highway driving may necessitate changing after 15,000 miles (24,000 km) of driving. When installing new plugs, be sure to fit the right type and use correct torque, see "Specifications". When changing the plugs, check that the suppressor connectors are in good condition. Cracked or damaged connectors should be replaced. When changing the spark plugs, clean the terminals and the rubber seals.

### Hoisting the car

If a garage jack is used to lift the car, the two jack attachments points should be used. They are specially reinforced to bear the weight of the car. A garage jack can also be placed under the front of the engine

support frame and under the reinforced plate in the spare wheel well. Take care not to damage the splash guard under the engine. Ensure that the jack is positioned so that the car cannot slide off it. Always use axle stands or similar structures.

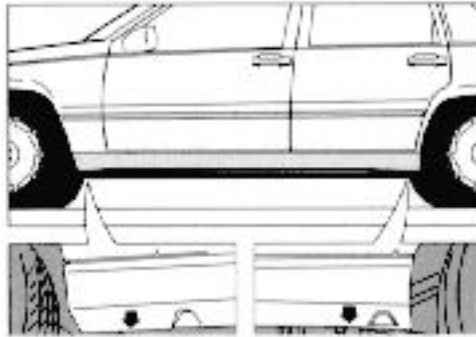

If a two-post hoist is used to lift the car, the front and rear lift arm pads should be centered under the reinforced lift plates on the inboard edge of the sill rail. The position of these plates is marked with arrows molded into the bottom of the sill rail.

**CAUTION:** T-5R turbo models have reduced ground clearance due to the design of the front spoiler. Please observe caution when driving the car onto a garage hoist.

[pg. 8:7 Servicing \(cont.\)](#)

### Torque exhaust and intake manifold nuts

A loose manifold could alter air/fuel ratio and cause an increase in emission and/or poor driveability.

### Air cleaner

Replace the air cleaner cartridge with a new one every 30,000 miles (48,000 km). The cartridge should be replaced more often when driving under dirty and dusty conditions. The filter cannot be cleaned and therefore should always be replaced with a new one.

### Vacuum fittings, hoses and connections

Unstable idle, misfiring or poor emission control is often caused by leaking vacuum hoses or connections. Check all vacuum hoses and connections.

### Checking and adjusting idle air control system

Your Volvo is equipped with an electronically controlled idle air control system that requires no checking or adjustment.

### Timing belt

For proper functioning of the vehicle and its emission control systems, Volvo recommends that the timing belt be replaced every 70,000 miles (112,000 km).

### Fuel system cap, tank and lines and connections

The effectiveness of the fuel system to contain hydrocarbons is dependent largely on a leak-free system. Check for proper sealing of the gasoline filler cap which contains " O " ring type seals.

### Fuel (line) filter

The fuel line filter is located next to the fuel pump. For proper functioning of the vehicle and its emission control systems, the fuel line filter should be replaced at 100,000 miles (160,000 km). The filter is replaced as one complete unit. Replace more frequently if contaminated fuel is introduced into the tank (or if there is reason to suspect that this has occurred).

### Exhaust Gas Recirculation (EGR)

This system operates by returning some of the exhausts gases to the engine to be recombusted since this lowers the combustion temperature and the amount of nitrogen oxides released into the atmosphere is reduced. The EGR valve should be cleaned at 100,000 miles (160,000 km) and thereafter cleaned every 20,000 miles (32,000 km).

### Charge air cooler (Intercooler)

The B 5234 Turbo engines employs a turbo-compressor to force air into the engine inlet manifold and a charge air cooler to cool the compressed inlet air. The resulting increase in air flow raises pressure in the intake manifold by approx. 8.7 psi (over atmospheric pressure) and engine power output by approx. 50 horsepower over that developed by the normally-aspirated engine. The charge air cooler (which resembles a radiator) is located between the turbo-compressor and inlet manifold.

pg. 8:8 Servicing (cont.)

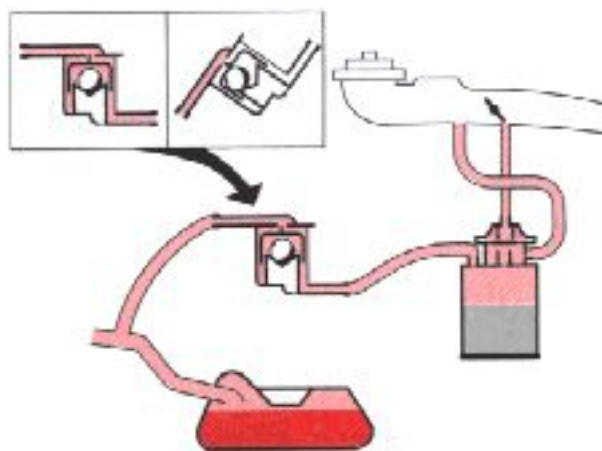

*A - roll over valve, B - vacuum valve,  
C - inlet manifold, D - charcoal canister,  
E - fuel tank*

## Fuel System

The fuel system is all-electronic and is microprocessor-controlled. It can continually compensate for variation in engine load, speed and temperature to give the best economy and power. A mass air flow sensor measures the inducted air. In this way the system can make instantaneous adjustments for changes in air temperature or density, thus always assuring the best economy with the lowest possible exhaust emissions.

## Heated oxygen sensor

This is an emission control system designed to reduce emissions and improve fuel economy. The heated oxygen sensor monitors the composition of the exhaust gases leaving the engine. The exhaust gas analysis is fed into an electronic module. This adjusts the air-fuel ratio to provide optimum conditions

for combustion and efficient reduction of the three major pollutants (hydrocarbons, carbon monoxide and nitrous gases) by a three-way catalytic converter.

### Secondary Air Injection (certain models)

This system adds air to the hot exhaust gases as they are expelled from the engine. This causes a secondary combustion of residual hydrocarbons and carbon monoxide, resulting in lower emissions levels in the exhaust gases.

### Evaporative control system

The car is equipped with a gas evaporative control system, which prevents gasoline fumes from being released into the atmosphere. The system is comprised of an expansion chamber in the fuel tank, a roll-over valve on the cross member in front of the fuel tank and a charcoal canister with a built-in vacuum valve under the left-front wheel housing. The components are interconnected by hoses which channel fuel vapor from the gas tank to the charcoal filter, where it is stored until the engine is started and then drawn into the engine's air intake system.

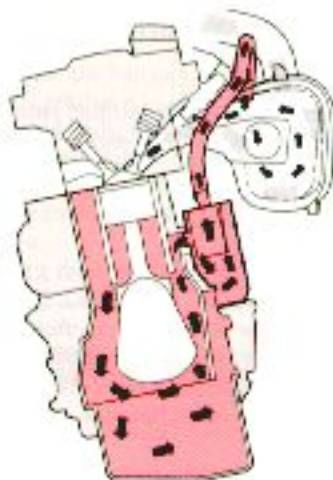

### Crankcase ventilation

The engine is provided with positive crankcase ventilation which prevents crankcase gases from being released into the atmosphere. Instead, the crankcase gases are admitted to the intake manifold and cylinders.

## PCV system

The orifice nipple in the intake manifold and the filter at the end of the PCV hose in the air cleaner should be inspected every 60,000 miles (96,000 km). Check/replace rubber hoses at the same time.

## pg. 8:9 Lubrication

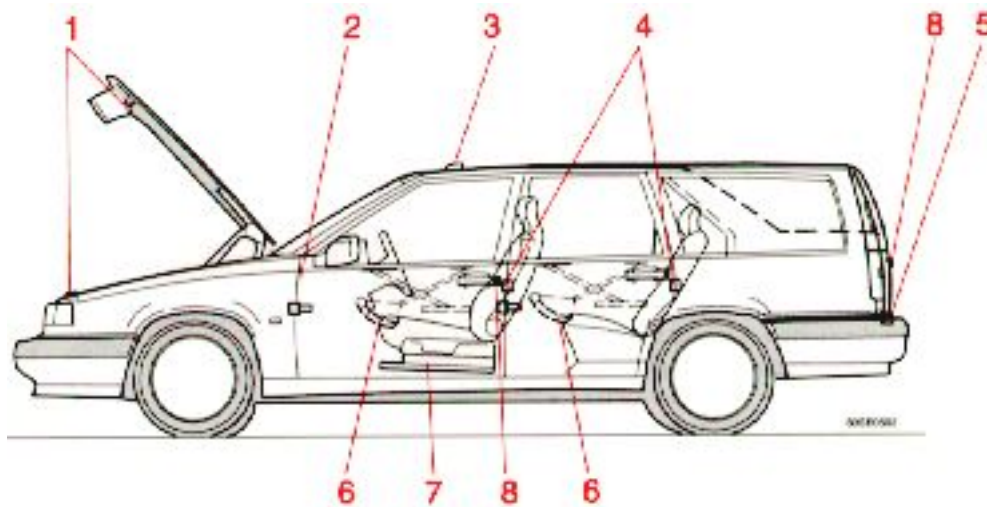

No.	Lubrication point	lubricant	No.	Lubrication point	lubricant
1	Hood lock and latch	Oil	6	Window winder (on inside of door)	Oil, grease, low temperature grease
2	Door stop and hinges	Oil	7	Front seat slide rail and latch	Oil
3	Sun roof wind deflector	Oil	8	Door locks	Volvo teflon lock spray
4	Door lock catch plate	Oil			
5	Trunk/tailgate lid lock	Low temperature grease			

To avoid rattles and unnecessary wear, the body should be lubricated a few times per year. This should be done by an authorized Volvo dealer.

## pg. 8:10 Engine oil



## Checking the oil level

The oil level should be checked every time the car is refuelled. This is especially important during the engine break-in period (up to the first service).

**CAUTION :** Not checking the oil level regularly can result in serious engine damage if the oil becomes too low.

Park the car on a level surface and wait for at least 3 minutes after the engine has been switched off. Be sure the oil level is maintained between the upper and lower marks on the dipstick. Low oil level can cause internal damage to the engine and over-filling can result in high oil consumption. The distance between the dipstick marks represents approx. 1 US qt (1 liter)\*. The oil should preferably be checked when cold, before the engine has been started.

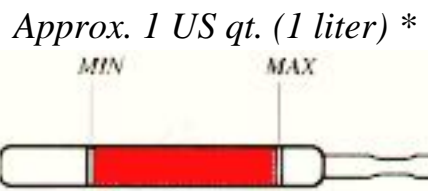

\* Certain models: 1.6 US qts (1.5 liters)

**NOTE:** The engine must be stopped when checking the oil.

## Draining the oil

Drain the oil after driving while it is still warm.

**WARNING!** The oil may be very hot.

If you change the engine oil and filter yourself, your Volvo dealer can assist you in disposing of the used oil. Engine oil can be harmful to your skin - gloves should worn when performing this work.

## To add or change oil

Add oil of the same kind as already used. Capacity (including filter): 5.6 US qts (5.3 liters) (certain models: 6.1 US qts/5.8 liters). Turbo models: 5.6 US qts (5.3 liters).\*\* The oil filter should be replaced at every oil change

\*\* Add 0.95 qts (0.9 liters) if the oil cooler has been drained.

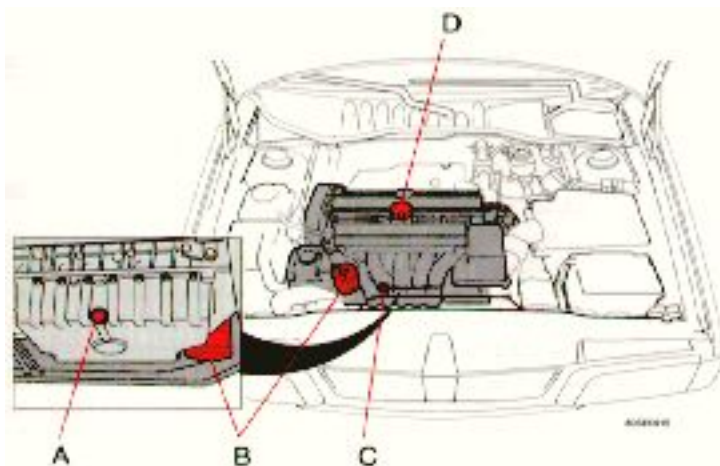

*A - Drain plug, B - Oil filter, C - Oil dipstick, D - Oil filler cap*

**WARNING!** Oil spilled on a hot exhaust pipe constitutes a fire risk.

[pg. 8:11 Engine oil \(cont.\)](#)

## Oil quality

Meeting API specification SG, SG/CD, SH or ILSAC GF-1

For best fuel economy and engine protection consult with your authorized Volvo dealer for recommended oils. Oils with a different quality rating may not provide adequate engine protection.

Viscosity (stable ambient temperatures):

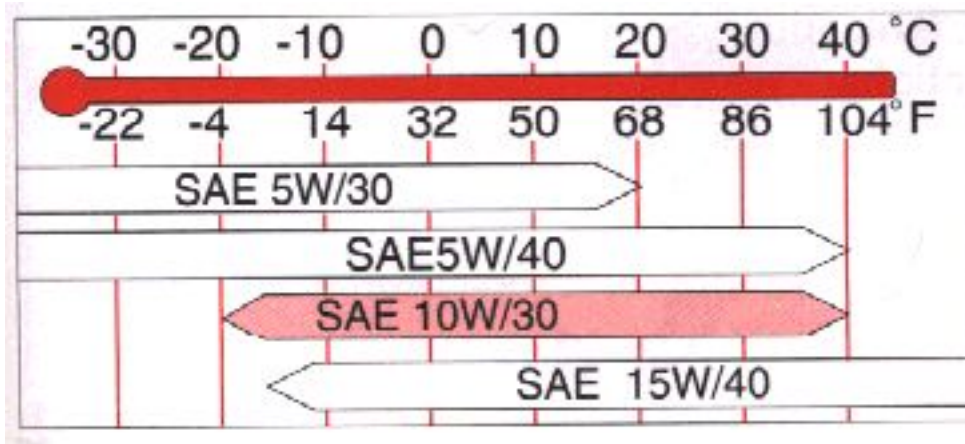

Do not use oils with other viscosity ratings. The use of incorrect viscosity oil can shorten engine life. Volvo recommends the use of energy-conserving oils. Look for the API label. Synthetic oils complying with oil quality requirements are recommended for: driving in areas of sustained temperature extremes (hot or cold), when towing a trailer over long distances or for a prolonged driving in mountainous areas. Extra oil additives must not be used unless advised by an authorized Volvo dealer. SAE 15W-40 is recommended for use in driving conditions that raise oil temperature and increase oil consumption (i.e., mountain driving, trailer towing).  
NOTE: SAE 15W-40 must not be used at low ambient temperatures; see viscosity chart

## Changing oil and oil filter

Oil and oil filter changes should be made as specified in the following table:

If driving conditions include:	Then the correct oil/oil filter change interval is:
<ul style="list-style-type: none"> <li>Extended periods of idling and/or low-speed operation</li> <li>Frequent short trips, less than 7 miles 11 km</li> <li>Extended periods of driving in dusty and/or sandy areas</li> <li>Trailer towing</li> <li>Driving in mountainous areas</li> </ul>	<p>EVERY 5,000 miles = 8,000 km OR EVERY 6 MONTHS, WHICHEVER COMES FIRST</p>
<ul style="list-style-type: none"> <li>Primarily highway driving</li> <li>Frequent trips of longer than 7 miles = 11 km</li> <li>Normal driving</li> </ul>	<p>EVERY 10,000 miles = 16,000 km 5,000 miles = 8,000 km * OR EVERY 12 MONTHS, WHICH EVER COMES FIRST</p>

\* Turbo models



American Petroleum Institute (API) labels. These labels certify that the oil conforms to the applicable standards and specifications of the API.



[Contents](#) | [Top of Page](#)

## Specifications

[pg. 9:1 Specifications](#)

### Specifications

This chapter contains facts and figures pertaining to the technical specifications of your car.

[9:2 Oil/fluids specifications](#)

[9:3 Engine specifications](#)

[9:4 Cooling/fuel distributor ignition systems](#)

[9:4 Front/rear suspensions](#)

[9:5 Transmission, Capacities, Vehicle loading](#)

[9:6 Electrical system/bulbs](#)

[9:7 Dimensions and weights](#)

[9:8 Service manuals, Road assistance](#)

[9:9 Customer support](#)

[pg. 9:2 Oil/fluid specifications](#)

### Oil quality

Meeting API specification SG, SG/CD, SH or ILSAC GF-1

For best fuel economy and engine protection, consult with your authorized Volvo dealer for recommended oils. Oil with a different quality rating may not provide adequate engine protection.

Synthetic oils complying with oil quality requirements are recommended. Volvo recommends the use of fuel economy improving oils. Look for the API label.

Synthetic oils complying with oil quality requirements are recommended for: driving in areas of sustained temperature extremes (hot or cold), when towing a trailer over long distances or for prolonged driving in mountainous areas.

Extra oil additives must not be used unless advised by an authorized Volvo dealer.

Viscosity (stable ambient temperatures):

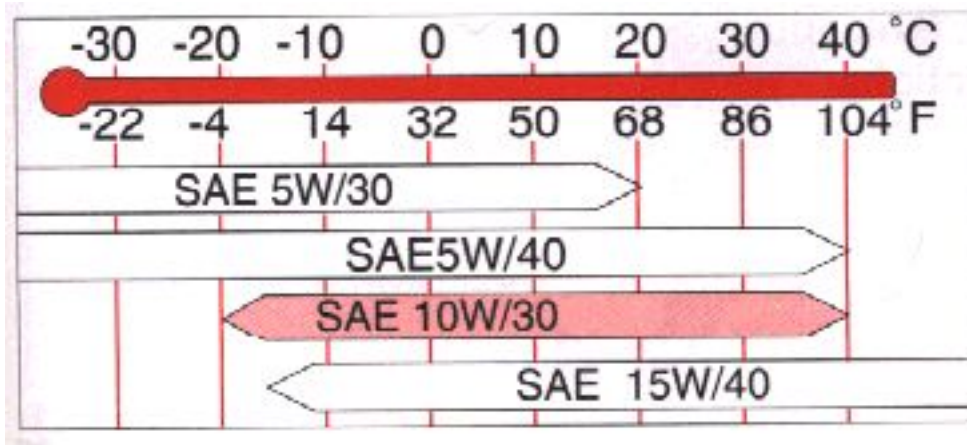

Engine oil

Quality: Meeting API specification SG

Capacity (incl. filter) : 850 (5-cyl. engine) 5.6 US qts. /5.3 liters (certain models: 6.1 US qts. /5.8 liters)

850 Turbo - 5.6 US qts. (5.3 liters)\*

\* Add 0.95 qts. (0.9 liters) if the oil cooler has been drained  
Capacity: 8 US qts (7.6 liters)

Automatic transmission fluid

Quality: ATF Dexron IIE or Mercon

Manual transmission fluid

Quality: Volvo synthetic gearbox oil 1161423

Capacity: 2.2 US qts. (2.1 liters)

Power steering fluid

Quality: ATF

Capacity: 0.85 US qts. (0.8 liters)

Brake fluid

Quality: DOT 4+

Capacity: 0.64 US qts. (0.6 liters)

All specifications are subject to change without notice.

## Engine

Liquid-cooled gasoline, 5-cylinder, in-line engine. Aluminum alloy cylinder block with cast-iron cylinder liners cast directly into the block. Aluminum alloy cylinder head with double overhead camshafts and separate intake and outlet channels.

Engine lubrication is provided by an eccentric pump driven from the crankshaft. Full-flow type oil filter. Exhaust emission control accomplished by multiport fuel injection, heated oxygen sensor(s) and three-way catalytic converter

Designation: Volvo B 5254 S

Output 168 hp at 6200 rpm (125 kw 103 rps)

Max torque 162.3 ft. lbs. at 4700 rpm (220 Nm/55 rps)

Number of cylinders 5

Bore 3.27" (83 mm)

Stroke 3.54" (90 mm)

Displacement 2.4 liters

Compression ratio 10.5:1

Number of valves 20

Valve clearance Self-adjusting

Designation: Volvo B 5252 S

Output 142 hp at 5400 rpm (106 kw/90 rps)

Max torque 152 lbs. at 3600 rpm (206 Nm/60 rps)

Number of cylinders 5

Bore 3.27" (83 mm)

Stroke 3.54" (90 mm)

Displacement 2.4 liters

Compression ratio 10.0:1

Number of valves 10

Valve clearance Self-adjusting

Designation: Volvo B 5234 T Turbo

Output 222 hp at 5280 rpm (166 kw/88 rps)

Max torque 221 ft. lbs. at 2000-5280 rpm (300 Nm/33-88 rps)  
Number of cylinders 5  
Bore 3.19" (81 mm)  
Stroke 3.54" (90 mm)  
Displacement 2.3 liters  
Compression ratio 8.5:1  
Number of valves 20  
Valve clearance Self-adjusting

Designation: Volvo B 5234 T-5R Turbo

Output 222 hp at 5280 rpm\* (166 kw/88 rps)\*  
Max torque 221 ft. lbs. at 2000-5280 rpm (300 Nm/33-88 rps)\*  
Number of cylinders 5  
Bore 3.19" (81 mm)  
Stroke 3.54" (90 mm)  
Displacement 2.3 liters  
Compression ratio 8.5:1  
Valve clearance Self-adjusting

\* The T-5R turbo engine generates increased power during a 30 second period:

237 hp at 5600 rpm (177 Kw at 94 rps)  
221 ft. lbs. at 2000-5600 rpm (33-94 rps)

All specifications are subject to change without notice.

[pg. 9:4 Specifications \(cont.\)](#)

## Cooling system

Type: Positive pressure, closed system  
Thermostat begins to open at 186°F (87°C)  
Turbo 180° F (87° C)  
Coolant: Volvo original coolant/anti-freeze  
Capacity: 7.6 US qts. (7.2 liters)  
Turbo - 7.4 US qts. (7.0 liters)



## Fuel system

The engine is equipped with a multiport fuel injection system (type LH-Jetronic 3.2 or Turbo models: Motronic 4.3)

## Distributor ignition system

Firing order 1-2-4-5-3

Distributor ignition setting Not adjustable

Spark plugs Bosch FR 6 DC (or equivalent)

Turbo: Champion RC7GYC (or equivalent)

Spark plug gap 0.028" (0.7 mm)

Tightening torque 18.4 ft. lbs. +/- 3.7 ft. lbs. (25 Nm +/- 5 Nm)

## Front suspension

Spring strut suspension with integrated shock absorbers and control arms linked to the support frame.

Power-assisted rack and pinion steering. Safety type steering column.

The alignment specifications apply to an unladen car but include fuel, coolant, and spare wheel.

Toe-in measured on the wheel rims: 2.4 mm +/- 0.7 mm

Toe-in measured on tire sides: 2.9 +/- 0.9 mm

## Rear Suspension

Delta-link individual rear-wheel suspension with longitudinal support arms, double link arms and track rods.

Toe-in measured on the tire sides: 4° +/- 10°

All specifications are subject to change without notice.

## Power transmission

### Manual transmission: M 56 H

Single-disc dry plate clutch. All-synchromesh on all gears including reverse; integrated final drive. Operation via a floor mounted gear lever. Overdrive.

Final drive ratio 4.00:1

#### Reduction ratios

1st gear 3.07:1

2nd gear 1.90:1

3rd gear 1.19:1

4th gear 0.87:1

5th gear 0.70:1

Reverse 3.00:1

### Automatic transmission: AW 50-42 LE

4-speed automatic electronically controlled gearbox comprising a hydraulic torque converter with a lock-up function; planetary gear, integrated final drive.

Operation via a floor mounted gear selector lever. Overdrive. Drive shafts with symmetrical joint location.

Final drive ratio 2.74:1 (Turbo: 2.54:1)

#### Reduction ratios

1st gear 3.61:1

2nd gear 2.06:1

3rd gear 1.37:1

4th gear 0.98:1

Reverse 3.95:1

## Capacities

Fuel tank 19.3 US gals (73 liters)

Cooling System 7.4 US qts. (7.0 liters)

Engine oil (incl. filter) 5.6 US qts. (5.3 liters)\*  
Automatic transmission 2 US gals (7.6 liters)  
Manual transmission 2.2 US qts. (2.1 liters)  
Power steering fluid 0.8 US qts. (0.8 liter)  
Washer fluid reservoir 3.2 US qts. (3.0 liters)  
Brake/clutch system 0.6 US qts (0.6 liters)

\* Certain models: 6.1 US qts. (5.8 liters)

Turbo: Add 0.95 US qt. (0.9 liters) if the oil cooler has been drained.

## Vehicle Loading

The tires on your Volvo should perform to specifications at all normal loads when inflated as recommended on the tire information label. The label is located on the inside of the fuel filler flap. The label lists both tire and vehicle design limits. Do not load your car beyond the load limits indicated.

**WARNING! Improperly inflated tires will reduce tire life, adversely affect vehicle handling and can possibly lead to failure resulting in loss of vehicle control without prior warning.**

All specifications are subject to change without notice.

[pg. 9:6 Specifications \(cont.\)](#)

## Electrical system

12 Volt, negative ground.

Voltage-controlled generator. Single-wire system with chassis and engine used as conductors.

### Battery

Voltage 12 Volt

Capacity 520 A/100 min

(certain markets) 420 A/75 min

The battery contains corrosive and poisonous acids. It is of the utmost importance that old batteries are

disposed of correctly. Your Volvo dealer can assist you in this matter.

## Generator

Rated output 1400 W

Max. current 100 A

## Bulbs

Bulb	US No.	Power	Socket	No/ bulbs
Headlights				
High beam	HB3/9005	70W	–	2
Low beam	HB4/9006	60W	–	2
Front parking lights/turn signals	1157 NA	21/5 W/24/2.2 cp	BAY 15 d	2
Turn signals, rear	–	21W	BAU 15 s	2
Tail lights (sedan)	67	5 W/4cp	BA 15 s	4
Tail lights (wagon)	–	21/4W	BAZ 15 d	4
Brake lights	1156	21W/32cp	BA 15 s	2
High-mounted brake lights	1156	21W/32cp	BA 15 s	1
Brake lights in spoiler	–	5W	W 2.1x9.5d	6

Bulb	US No.	Power	Socket	No/ bulbs
Back-up lights	1156	21W/32cp	BA 15 s	2
Rear fog light (sedan)	1156	21W/32cp	BA 15 s	1
Rear fog light (wagon)	–	21/4W	BAZ 15 d	1
Front fog lights	H3	55 W	PK 22 s	2
License plate light	–	5 W	W 2.1x9.5d	2
Door open warning light	–	3 W	W 2.1x9.5d	4

Door step courtesy light	–	5W	W 2.1x9.5d	2
Trunk light	–	10 W	SV 8.5	1
Glove compartment light	–	2 W	BA 9s	1
Vanity mirror lights	–	1.2 W	–	2
Instrument lighting	–	3 W	W 2.1x9.5d	3
illumination, control panel	–	1.2 W	W 2x4.6 d	–
gear selector (automatic trans.)	–	1.2 W	W 2x4.6 d	1
rear ashtray	–	1.2 W	W 2x4.6 d	1
seat belt lock	–	1.2 W	W 2x4.6 d	1
Instrument warning/indicator lights	–	1.2 W	W 2x4.6 d	–
Front courtesy lights	–	5 W	BA 9s	2
Rear reading lights	–	5 W	BA 9s	2

All specifications are subject to change without notice



[Contents](#) | [Top of Page](#)

pg. 9:7 Specifications (cont.)

## Dimensions and weights

Length 183.4 in. (466 cm)

Width 69.3 in. (176 cm)

Height 55.9 in. (142 cm)

Wheelbase 104.7 in. (266 cm)

Track, front 59.8 in. (152 cm)

Track, rear 57.9 in. (147 cm)

Turning circle (between curbs) 33.5 ft. (10.2 m)

Trunk capacity 14.7 cu. ft. (0.44 m<sup>3</sup>?)

**WARNING! When adding accessories, equipment, luggage and other cargo to your vehicle, the total loaded weight capacity of the vehicle must not be exceeded.**

## Gross vehicle weight (GVW) USA Canada

850 (sedan) 4180 lbs (1896 kg) 1900 kg

850 (wagon) 4340 lbs (1969 kg) 1970 kg

850 Turbo (sedan) 4250 lbs (1928 kg) 1930 kg

850 Turbo (wagon) 4340 lbs (1969 kg) 1970 kg

## Capacity weight \*

850 (sedan) 930 lbs (422 kg) 425 kg

850 (wagon) 995 lbs (451 kg) 455 kg

850 Turbo (sedan) 930 lbs (422 kg) 425 kg

850 Turbo (wagon) 940 lbs (426 kg) 425 kg

850 T-5R Turbo (sedan) 885 lbs (401 kg) 400 kg

850 T-5R Turbo (wagon) 885 lbs (401 kg) 400 kg

\* The max permissible axle loads or the gross vehicle weight must not be exceeded.

## Curb weight USA Canada

850 sedan 3120-3340 lbs (1415-1515 kg) 1385-1515 kg

850 wagon 3230-3460 lbs (1465-1569 kg) 1465-1570 kg

Permissible axle weight, front

850 (sedan) 2240 lbs (1016 kg) 1020 kg  
850 (wagon) 2240 lbs (1016 kg) 1020 kg  
850 Turbo (sedan) 2290 lbs (1039 kg) 1040 kg  
850 Turbo (wagon) 2290 lbs (1039 kg) 1040 kg

Permissible axle weight, rear

850 (sedan) 1980 lbs (898 kg) 900 kg  
850 (wagon) 2220 lbs (1007 kg) 1010 kg  
850 Turbo (sedan) 1980 lbs (898 kg) 900 kg  
850 Turbo (wagon) 2220 lbs (1007 kg) 1010 kg

Max. roof load \*\* 220 lbs (100 kg) 100 kg

Max. trailer weight

(w/o brakes) 1540 lbs (700 kg) 700 kg  
(with brakes)  
2" ball 3300 lbs (1500 kg) 1500 kg  
1 7/8" ball 2000 lbs (908 kg) 900 kg

Max. tongue weight \*\*\* 165 lbs (75 kg) 75 kg

\*\* For permanent roof racks, check the manufacturer's weight specifications.

\*\*\* See also section "Trailer towing"

All specifications are subject to change without notice.

[pg. 9:8 Service manuals, Road assistance](#)

Service Manuals for your Volvo are available for purchase. These are the same manuals used by competent Volvo technicians.

Major sections within the Service Manual System include: 0- General Information; 1- Lubrication and Service; 2- Engine; 3- Electrical System; 4- Power Transmission; 5- Brakes; 6- Suspension and Steering; 7- Springs Shock Absorbers and Wheels; 8- Body and Interior.

A Literature Catalog Request Card was placed in the car prior to delivery from the dealer to you. Complete ordering information is provided.



Volvo supports Voluntary Mechanic Certification by the A.S.E. Certified mechanics have demonstrated a high degree of competence in specific areas. Besides passing exams each mechanic must also have worked in the field for two or more years before a certificate is issued. These professional mechanics are fully able to analyze vehicle problems and perform the necessary service procedures to keep your Volvo at peak operating condition.

NOTE: The above pertains to the USA only.



Your new Volvo comes with a four year road assistance program named ON-CALL. Additional information, features, and benefits are described in a separate information package in your glove



compartment.

All specifications are subject to change without notice.

[pg. 9:9 Customer Support](#)

Vehicle Information (see "Label information" section)

Vehicle License Number \_\_\_\_\_

Vehicle Identification Number (VIN) \_\_\_\_\_

Service Designation Number \_\_\_\_\_

Engine Designation (see Specification" section) \_\_\_\_\_

Color code \_\_\_\_\_

Upholstery \_\_\_\_\_

Tire designation (see "Tires" section) \_\_\_\_\_

Vehicle capacity \_\_\_\_\_

[Inside Back Cover](#)

## WARNING!

### Detergents and solvents

Do not use gasoline containing lead or benzene as a detergent or solvent. Both lead and benzene are toxic and may be hazardous to your health.

### Installation of optional equipment/use of mobile telephones

Incorrectly installed optional equipment, alarm systems or the use of mobile telephones which are not connected to a suitable antenna can cause faults in the car's electronic control systems. Your car is equipped with an accessory connector located under the dashboard on the driver's side. Please consult your Volvo dealer if you have any questions before connecting accessory or optional equipment to the vehicle's electrical systems.

### Carbon monoxide

Carbon monoxide is a poisonous, colorless and odorless gas which is present in all exhaust gases. If you ever smell exhaust fumes from inside the vehicle, make sure the passenger compartment is ventilated and immediately return the vehicle to your dealer for correction.

Never sit in a parked or stopped car for any extended amount of time, nor have it unattended while the engine is running.

Never operate the engine in confined, unventilated areas.

## [Back Cover](#)

The following should be checked regularly: \*

1 Washer fluid reservoir should be filled with water and solvent (wintertime: windshield washer anti-freeze). See page 8:15.

2 Coolant level should be between the expansion tank marks. Mixture: 50% anti-freeze and 50% water. See page 8:16.

3 Power steering - When cold, the level must not be above the COLD mark and when hot it must not be above the HOT mark. Top up if the level drops to the ADD mark with ATF fluid. See

page 8:12.



4 Engine oil level should be between the dipstick marks. The distance between the marks represents approx. 1 US qt. (1 liter) or on certain models 1.6 US qts (1.5 liters). See page 8:10.

5 Brake fluid - check, without removing the cap, that the level is above the MIN mark. Use brake fluid DOT 4+. See page 8:12.

\* Engine oil should be checked each time the car is refuelled.

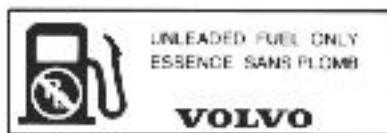

Octane rating, see page 4:3

Tire pressure, see label located on inside of fuel filler flap.



Bulbs	Power	Socket	US Bulb No.
1	70 W	P 20d	HB3/9005
2	60 W	P 22d	HB4/9006

3	24/5 W	BAY 15 d	1157NA
4	21 W	BA 15 s	1156
5	21/4 W	BAZ 15 d	–
6	5 W	BA 15 s	67
7	21 W	BAU 15 s	–

See pages 6:5-8 for more detailed information

VOLVO

Volvo Car Corporation  
Göteborg, Sweden

TP 3593/3 (Canada & USA) 50.000.12.94 Printed in Sweden, Graphic Systems AB, Göteborg  
199



[Contents](#) | [Top of Page](#)